

# D10 Expert™ – Dual Discrete Outputs

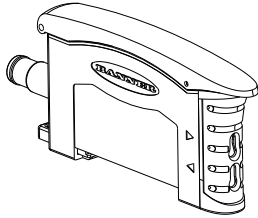

## Datasheet

Advanced sensor for use with plastic fiber optics



- Easy-to-set automatic Expert-style TEACH options including static, dynamic, and single-point programming plus manual adjustment for fine-tuning
- 16-bit microcontroller and 12-bit Analog-to-Digital converter for high-performance, low-contrast sensing
- Easy-to-read four-digit display for TEACH and signal strength readout, plus indicators for a continuous readout of operating status (user configurable)
- Two discrete outputs, PNP or NPN
- Four-mode power and speed selection with automatic cross-talk avoidance circuitry
- Selectable OFF-delay options
- Gate input wire can be used to selectively inhibit sensor outputs from switching
- Models available with visible red (680 nm) or visible green (525 nm) sensing beam
- Models available with 2 m or 9 m (6.5 ft or 30 ft) cable or integral M8 quick-disconnect
- Sleek, ultra-slim 10 mm housing, mounts to a standard 35 mm DIN rail



### WARNING:

- **Do not use this device for personnel protection**
- Using this device for personnel protection could result in serious injury or death.
- This device does not include the self-checking redundant circuitry necessary to allow its use in personnel safety applications. A device failure or malfunction can cause either an energized (on) or de-energized (off) output condition.

## Models

Red Beam Models	Green Beam Models	Cables <sup>1</sup>	Discrete Outputs
D10DNFP	D10DNFPG	2 m (6.5 ft) Cable	NPN
D10DNFPQ	D10DNFPGQ	6-pin M8 QD	
D10DPFP	D10DPFPG	2 m (6.5 ft) Cable	PNP
D10DPFPQ	D10DPFPGQ	6-pin M8 QD	

## Overview

The D10 *Expert* Sensor is a high-performance plastic fiber-optic sensor whose many configuration (TEACH-mode) options make it suitable for demanding applications. Even with all its features, it is extremely easy to use. Advanced 16-bit microcontroller technology makes this possible.

The D10 *Expert* provides high-performance sensing in low-contrast applications. *Expert* TEACH and setup options provide static, dynamic and single-point programming plus manual fine adjustment, remote programming and push button lockout. Its slender, stylized housing has a large digital display visible beneath a clear cover for easy programming and status monitoring during operation. The sensor mounts directly to standard 35 mm DIN rail or using the supplied mounting bracket.

The sensor features two outputs with independent setpoints: either NPN or PNP, depending on model. Built-in crosstalk avoidance protocol provides trouble-free operation for multiple sensors in one area.

For emitter and receiver port locations, see [Installation](#) on page 2.

Figure 1. D10 Features

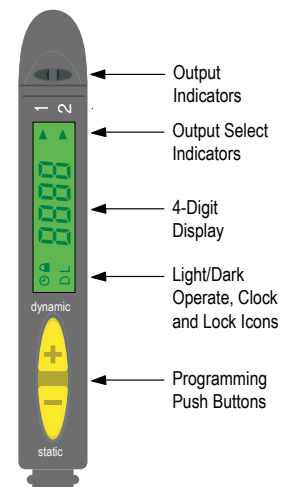

<sup>1</sup> To order the 9 m (30 ft) PVC cable model, add the suffix "W/30" to the cabled model number. For example, D10DNFP W/30. Models with a quick disconnect require a mating cordset.



## Programming Options

### Light/Dark Operate Selection

Toggle to select the condition for which each output will conduct: when the target is present or when the target is absent.

### OFF-Delay Timing Selection

Programmable OFF-delay pulse stretcher: 0, 2, 5, 10, 15, 20, 30, 40, 60, 80, or 100 ms

### Display Selection

Discrete Output: Raw signal value or % excess signal

### Tracking Feature

Sets Output 2 to identical settings as Output 1; Output 2 settings can then be revised as desired (see [Advanced Setup](#) on page 10).

### Speed Selection, Response Time, and Repeatability

Power Level/Speed Selection		Super High-Speed (SHS) <sup>2</sup>		High-Speed (HS)		High-Power (HP)		Super High-Power (SHP)	
Response <sup>3</sup>		50 µs		200 µs		1 ms		2.5 ms	
Repeatability		25 µs		50 µs		75 µs		100 µs	
Max Range <sup>3</sup>	Fiber	Red 680 nm	Green 525 nm	Red 680 nm	Green 525 nm	Red 680 nm	Green 525 nm	Red 680 nm	Green 525 nm
	PIT16U	20 mm	9 mm	30 mm	9 mm	55 mm	13 mm	90 mm	16 mm
	PIT26U	100 mm	40 mm	150 mm	40 mm	250 mm	55 mm	400 mm	70 mm
	PIT46U	300 mm	100 mm	550 mm	100 mm	1000 mm	160 mm	1200 mm	180 mm
	PIT66U	600 mm	180 mm	1000 mm	180 mm	1700 mm	280 mm	2400 mm	320 mm
	PBT16U	6 mm	<sup>4</sup>	10 mm	<sup>4</sup>	18 mm	3 mm	30 mm	3.5 mm
	PBT26U	30 mm	12 mm	50 mm	12 mm	100 mm	20 mm	150 mm	25 mm
	PBT46U	100 mm	30 mm	175 mm	30 mm	250 mm	42 mm	300 mm	60 mm
	PBT66U	175 mm	55 mm	250 mm	55 mm	400 mm	80 mm	475 mm	100 mm

**Factory Default Settings**—The following settings are preset at the factory; revert sensor to factory defaults using Advanced Setup procedure (see [Advanced Setup](#) on page 10).

- Light operate (LO)
- No OFF-delay (t 0)
- Raw signal value (1234)
- Output 1 displayed
- High Speed (HS); 200 µs response
- Maximum power setting
- Discrete: switchpoint positioned at middle of range

## Sensor Programming

**Programming Procedures:** Two push buttons, Dynamic (+) and Static (-), may be used to access and set programming parameters. For remote programming, connect a switch or digital input to the gray wire; length of the individual pulses is equal to the value T: **0.04 seconds ≤ T ≤ 0.8 seconds**

**Returning to RUN mode:** TEACH and SETUP modes each may be exited in one of two ways: by exercising the 60-second time-out, or by cancelling out of the process. In TEACH mode, the sensor will return to RUN mode without saving any of the new settings; in SETUP mode, the sensor will return to RUN mode but save all of the settings. To cancel out of TEACH mode, press and hold the Static (-) button for 2 seconds; to cancel out of SETUP mode, press and hold both the Static (-) and Dynamic (+) buttons for 2 seconds.

**Output 2:** The setpoint(s) for each output can be set independently of one another (see Super-High Speed Operation). However, the functional range available for output 2 is dictated by the automatic power and gain settings established for output 1. Whenever output 1 is taught, output 2 also must be retaught. Applications hint: teach the weakest signal on output 1 first.

## Installation

Install the product on a 35 mm DIN rail or the included mounting bracket.

<sup>2</sup> See the Super High-Speed note under Sensor Setup.

<sup>3</sup> Diffuse mode performance based on 90% reflectance white test card.

<sup>4</sup> ø0.010-inch bifurcated fiber not recommended in these speed settings. Contact Banner Engineering for more information.

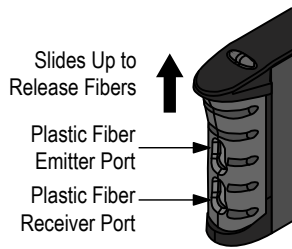

## Wiring Diagrams

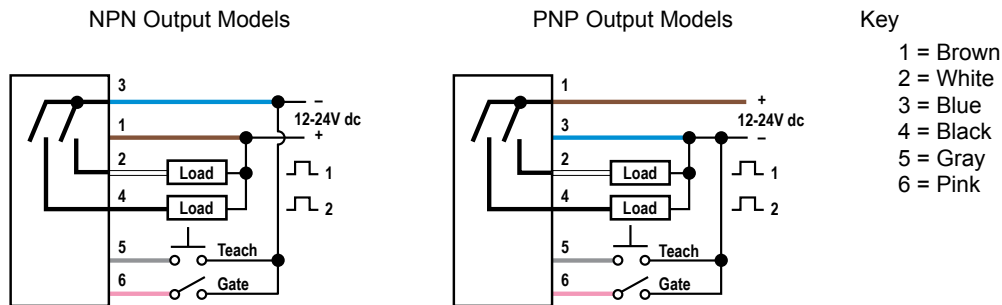



Quick disconnect wiring diagrams are functionally identical.

## Configuration Instructions

### Active Channel Select

- Selects which channel to teach
- Displays channel configuration information.

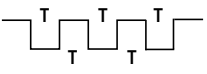
The duration of each button click or remote input pulse is defined as T, where T is: 0.04 s < T < 0.8 s.

Method	Action	Result
<b>Push Button</b>	Single-click both buttons simultaneously. 	<b>Pointer icon:</b> moves to the other channel indicator.
<b>Remote Input</b>	Triple-pulse the remote line. Triple-pulse will change the display, but will not save. To save Channel Select, make an adjustment to that channel as a TEACH, SET, or Sensor Setup. 	

### Two-Point Static TEACH (Threshold)

- Establishes a single switching threshold
- Threshold position is adjustable using “+” and “-” buttons (see [Manual Adjust](#) on page 9)

Static TEACH is the traditional setup method, used when two conditions can be presented by the user. The sensor locates a single sensing threshold (the switchpoint) midway between the two taught conditions, with the Output ON condition on one side, and the Output OFF condition on the other.

The first condition taught is the ON condition. The Output ON and OFF conditions can be reversed by changing Light/Dark Operate status in Setup mode (see [Sensor Setup](#) on page 9).

#### Static TEACH and Manual Adjust

Using Manual Adjust with Static TEACH moves the switching threshold.

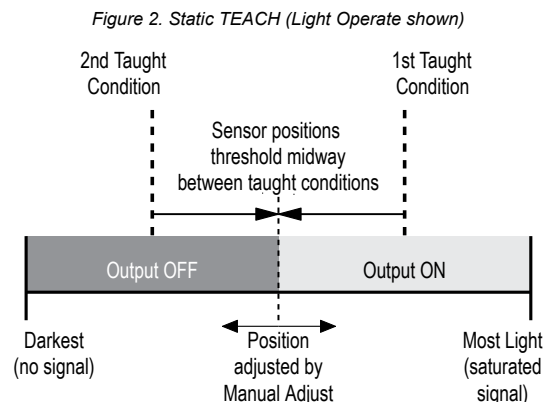



The duration of each button click or remote input pulse is defined as T, where T is: 0.04 s < T < 0.8 s.



Table 1: Contrast values

Contrast Values	Description
500+	Excellent: Very stable operation.
100-500	Good: Minor sensing variables will not affect sensing reliability.
32-99	Low: Minor sensing variables may affect sensing reliability.
0-31	Marginal: Consider an alternate sensing scheme.





1. Access the Static TEACH Mode.

Method	Action	Result
<b>Push Button</b>	Press and hold the Static (-) button > 2 seconds. 	<ul style="list-style-type: none"> <li>Display flashes "1St"</li> <li>Arrow icon turns red</li> </ul> 
<b>Remote Input</b>	No action is required; the sensor is automatically ready for the 1st TEACH condition.	

2. TEACH the Output ON condition.

Method	Action	Result
<b>Push Button</b>	a. Present the Output ON condition. b. Click the Static button. 	Display flashes "2nd"
<b>Remote Input</b>	a. Present the Output ON condition. b. Single-pulse the remote line. 	

3. TEACH the Output OFF condition.

Method	Action	Result
<b>Push Button</b>	a. Present the Output OFF condition. b. Click the Static button. 	<p><b>TEACH conditions accepted</b></p> <ul style="list-style-type: none"> <li>Display flashes "PASS," followed by a number (denoting contrast); see Table 1 on page 4. </li> <li>Sensor returns to RUN mode with new settings</li> <li>Arrow icon turns green</li> </ul> <p><b>TEACH conditions not accepted</b></p> <ul style="list-style-type: none"> <li>Display flashes "FAIL" and returns to "1St" </li> <li>After 60 seconds, sensor returns to RUN mode (Arrow icon turns green) without changing settings </li> </ul>
<b>Remote Input</b>	a. Present the Output OFF condition. b. Single-pulse the remote line. 	

## Dynamic TEACH and Adaptive Thresholds

Figure 3. Dynamic TEACH (Light Operate shown)

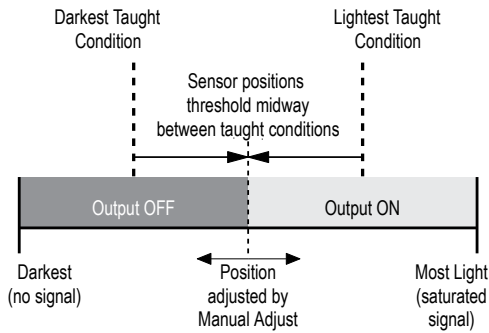

Figure 4. Dynamic Contrast Values

Contrast Values	
500+	<b>Excellent:</b> Very stable operation.
100-500	<b>Good:</b> Minor sensing variables will not affect sensing reliability.
32-99	<b>Low:</b> Minor sensing variables may affect sensing reliability.
0-31	<b>Marginal:</b> Consider an alternate sensing scheme.

- TEACH on-the-fly
- Sets a single threshold
- Threshold position is adjustable using the “+” and “-” buttons (see [Manual Adjust](#) on page 9)



Dynamic TEACH is used to program sensitivity during actual machine run conditions. During Dynamic TEACH, the sensor takes multiple samples of the light and dark conditions and automatically sets the sensitivity at the optimum level. Dynamic TEACH activates the sensor’s adaptive threshold system, which continuously tracks minimum and maximum signal levels, and automatically maintains centering of the switch point between the light and dark conditions. The adaptive threshold system remains in effect during RUN mode to automatically adjust for changes in the light or the dark conditions.

When Dynamic TEACH mode is used to program sensitivity, the output ON state (light or dark operate) will remain as it was last programmed. To change to either light or dark operate, use the SETUP mode (see [Sensor Setup](#) on page 9).

**Dynamic TEACH and Manual Adjust**— Sensitivity may be adjusted at any time when the sensor is in RUN mode by clicking the “+” and “-” buttons. However, when a manual adjustment is made, the adaptive threshold system is disabled (cancelled).

The duration of each button click or remote input pulse is defined as T, where T is: 0.04 s < T < 0.8 s.

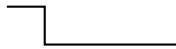
1. Access the Dynamic TEACH Mode.

Method	Action	Result
<b>Push Button</b>	Press and hold the Dynamic (+) button.	 <ul style="list-style-type: none"> <li>• Display flashes “dYn”</li> <li>• Arrow icon turns red</li> </ul>
<b>Remote Input</b>	Hold the remote line low (to ground).	 

2. TEACH the Sensing Conditions.

Method	Action	Result
<b>Push Button</b>	Present the Output ON/OFF conditions while continuing to hold the Dynamic button.	
<b>Remote Input</b>	Present the Output ON/OFF conditions while continuing to hold the remote line low (to ground).	

3. Return to RUN Mode.

Method	Action	Result
<b>Push Button</b>	Release the Dynamic button.	<b>TEACH conditions accepted</b> <ul style="list-style-type: none"> <li>• Display flashes “PASS,” followed by a number (denoting contrast); see <a href="#">Figure 4</a> on page 5</li> <li>• Sensor returns to RUN mode with new settings</li> <li>• Arrow icon turns green</li> </ul> 
<b>Remote Input</b>	Release the remote line/switch.	

### Single-Point Window Set

- Sets a single ON condition that extends 200 counts above and below the taught condition (including  $\pm 100$  counts hysteresis)
- All other conditions (lighter or darker) result in OFF output
- Sensing window size (sensitivity) is adjustable using “+” and “-” buttons (see [Manual Adjust](#) on page 9)

The duration of each button click or remote input pulse is defined as T, where T is:  $0.04 \text{ s} < T < 0.8 \text{ s}$ .

Window Set is most useful when a product may not always appear in the same place, or when other signals may appear. Window Set designates a sensing window, with the Output ON condition inside the window, and the Output OFF conditions outside the window. The sensor accepts a single sensing condition, and adds switching thresholds and hysteresis above and below that condition to create a sensing window. Output ON and OFF conditions can be reversed by changing Light/Dark Operate status in Setup mode.

#### Window Set and Manual Adjust

Using Manual Adjust with Window Set expands or contracts the size of the window.

Figure 5. Single-Point Window SET and Hysteresis (Light Operate shown)

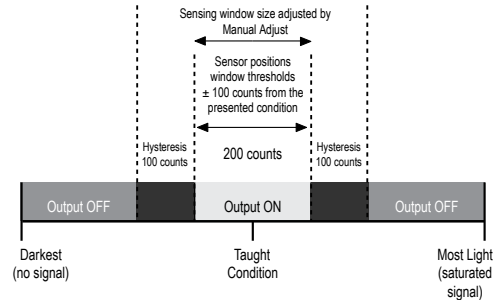

#### 1. Access the SET Mode.

Method	Action		Result
Push Button	Press and hold the Static (-) button > 2 seconds.		<ul style="list-style-type: none"> <li>• Display flashes “1St”</li> </ul>
Remote Input	a. Present the sensing condition. b. Single-pulse the remote line.		<ul style="list-style-type: none"> <li>• Display flashes “2nd”</li> </ul>

#### 2. SET the sensing condition.

Method	Action		Result
Push Button	a. Present the sensing condition. b. Double-click the Static button.		<p><b>TEACH conditions accepted</b></p> <ul style="list-style-type: none"> <li>• Display flashes “Sn6L,” then “Pt”</li> </ul> <p>twice</p> <ul style="list-style-type: none"> <li>• Sensor returns to RUN mode with new settings</li> <li>• Arrow icon turns green</li> </ul> <p><b>TEACH conditions not accepted</b></p> <ul style="list-style-type: none"> <li>• Display flashes “FAIL” and returns to “1St”</li> </ul> <ul style="list-style-type: none"> <li>• Arrow icon remains red</li> <li>• After 60 seconds, the sensor returns to RUN mode (the arrow icon turns green) without changing settings</li> </ul>
Remote Input	Double-pulse the remote line.		

## Single-Point Light Set

- Sets a threshold slightly below the taught condition.
- Any condition darker than the threshold condition causes the output to change state
- Threshold position is adjustable using the “+” and “-” buttons (see [Manual Adjust](#) on page 9)
- Recommended for applications where only one condition is known, for example a stable light background with varying darker targets

A single sensing condition is presented, and the sensor positions a threshold slightly below the presented condition. When a condition darker than the threshold is sensed, the output either turns ON or OFF, depending on the Light/Dark Operate setting (see [Sensor Setup](#) on page 9).

**Light SET and Light/Dark Operate Selection**— Light Set teaches the Output OFF condition and forces the sensor into Dark Operate (DO) mode. The sensor can be reconfigured to Light Operate (LO) mode after the condition has been taught (see [Sensor Setup](#) on page 9).

Figure 6. Single-Point Light Set (Light Operate shown)

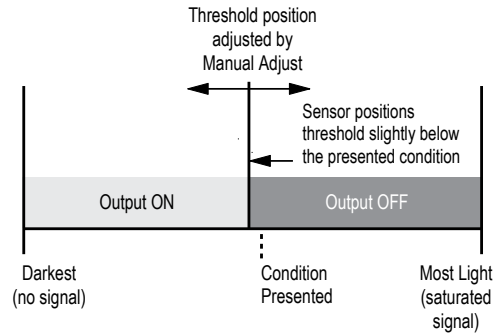





The duration of each button click or remote input pulse is defined as T, where T is: 0.04 s < T < 0.8 s.



Table 2: Light set threshold offset

Mode	Threshold Offset (counts below taught signal value)
Super High-Speed	30
High-Speed	22
High-Power	9
Super High-Power	6

### 1. Access the SET Mode.

Method	Action	Result
<b>Push Button</b>	Press and hold the Static (-) button > 2 seconds. 	<ul style="list-style-type: none"> <li>• Display flashes “1St”</li> <li>• Arrow icon turns red</li> </ul> 
<b>Remote Input</b>	Single-pulse the remote line. 	<ul style="list-style-type: none"> <li>• Display flashes “2nd”</li> <li>• Arrow icon turns red</li> </ul> 

### 2. SET the Output OFF condition.

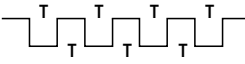
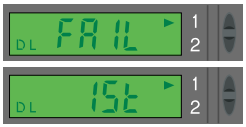
Method	Action	Result
<b>Push Button</b>	a. Present the Output OFF condition.  b. Four-click the Static button.	<b>Threshold condition accepted</b> <ul style="list-style-type: none"> <li>• Display flashes “Sn6L,” then “Lt”</li> </ul> twice  <ul style="list-style-type: none"> <li>• Sensor returns to RUN mode with new settings</li> <li>• Arrow icon turns green</li> </ul>
<b>Remote Input</b>	a. Present the Output OFF condition.  b. Four-pulse the remote line.	<b>Threshold conditions not accepted</b> <ul style="list-style-type: none"> <li>• Display flashes “FAIL” and returns to “1St”</li> </ul>  <ul style="list-style-type: none"> <li>• Arrow icon remains red</li> <li>• After 60 seconds, the sensor returns to RUN mode (the Arrow icon turns green) without changing settings</li> </ul>

### Single-Point Dark Set

- Sets a threshold slightly above the taught condition
- Any condition lighter than the threshold condition causes the output to change state
- Threshold position is adjustable using the “+” and “-” buttons (see [Manual Adjust](#) on page 9)
- Recommended for applications where only one condition is known, for example a stable dark background with varying lighter targets

A single sensing condition is presented, and the sensor positions a threshold slightly above the taught condition. When a condition lighter than the threshold is sensed, the output either turns ON or OFF, depending on the Light/Dark Operate setting (see [Sensor Setup](#) on page 9).

**Dark Set and Light/Dark Operate Selection**— Dark Set teaches the Output OFF condition and forces the sensor into Light Operate (LO) mode. The sensor can be reconfigured to Dark Operate (DO) mode after the condition has been taught (see [Sensor Setup](#) on page 9).

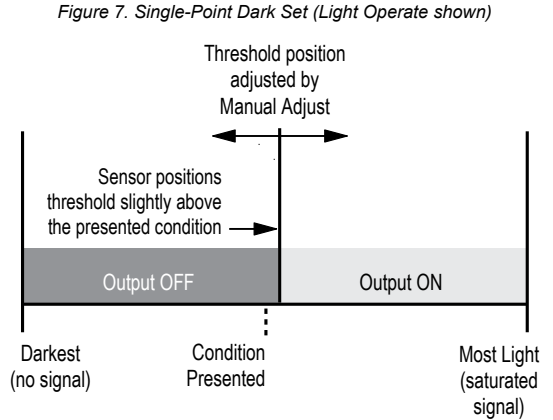





The duration of each button click or remote input pulse is defined as T, where T is: 0.04 s < T < 0.8 s.







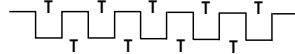

Table 3: Dark set threshold offset

Mode	Threshold Offset (counts above taught signal value)
Super High-Speed	30
High-Speed	22
High-Power	9
Super High-Power	6

1. Access the Set Mode.

Method	Action	Result
Push Button	Press and hold the Static button > 2 seconds. 	<ul style="list-style-type: none"> <li>• Display flashes “1St”</li> <li>• Arrow icon turns red</li> </ul> 
Remote Input	Single-pulse the remote line. 	<ul style="list-style-type: none"> <li>• Display flashes “2nd”</li> <li>• Arrow icon turns red</li> </ul> 

2. Set the Output OFF condition.

Method	Action	Result
Push Button	a. Present the Output OFF condition.  b. Five-click the Static button. 	<p><b>Threshold condition accepted</b></p> <ul style="list-style-type: none"> <li>• Display flashes “Sn6L,” then “dr”</li> </ul>  <p>twice</p>  <ul style="list-style-type: none"> <li>• Sensor returns to RUN mode with new settings</li> <li>• Arrow icon turns green</li> </ul> <p><b>Threshold condition not accepted</b></p> <ul style="list-style-type: none"> <li>• Display flashes “FAIL” and returns to “1St”</li> </ul>   <ul style="list-style-type: none"> <li>• Arrow icon remains red</li> <li>• After 60 seconds, the sensor returns to RUN mode (the Arrow icon turns green) without changing settings</li> </ul>
Remote Input	a. Present the Output OFF condition.  b. Five-pulse the remote line.	<p><b>Threshold condition not accepted</b></p> <ul style="list-style-type: none"> <li>• Display flashes “FAIL” and returns to “1St”</li> </ul>   <ul style="list-style-type: none"> <li>• Arrow icon remains red</li> <li>• After 60 seconds, the sensor returns to RUN mode (the Arrow icon turns green) without changing settings</li> </ul>



## Manual Adjust

Manual Adjust is used during Run mode and is accomplished using the push buttons only. Its behavior depends on whether a switching threshold or a sensing window is used.





### Switching Threshold:

- Fine-tunes sensing sensitivity
- Press “+” to increase; press “-” to decrease

### Sensing Window:

- Adjusts sensing window size (tolerance) for the single-point target condition
- Press “+” to increase; press “-” to decrease

The duration of each button click or remote input pulse is defined as T, where T is: 0.04 s < T < 0.8 s.

Method	Action	Result
<b>Push Button</b>	Click “+” to increase, or click “-” to decrease.  	Display briefly flashes the threshold setpoint value as it is being changed   <b>OR</b> Display flashes “inc” or “dEc” as the window size is adjusted  or 
<b>Remote Input</b>	Not available with remote programming.	n/a

## Sensor Setup



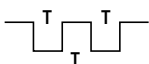

- Configures sensor display and operating parameters
- Changes are updated instantly
- Click Dynamic (+) or double-pulse remote line to select an option
- Click Static (-) or single-pulse remote line to advance

The duration of each button click or remote input pulse is defined as T, where T is: 0.04 s < T < 0.8 s.

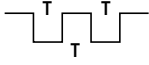

### 1. Access SETUP Mode.

Method	Action	Result
<b>Push Button</b>	Press and hold both buttons concurrently for > 2 seconds.  	The indicator arrow icon 1 is ON red.
<b>Remote Input</b>	Double-pulse the remote line.  	



### 2. Select Light/Dark Operate.

Method	Action	Result
<b>Push Button</b>	a. Click Dynamic (+) to toggle between selections. b. Click Static (-) to save selection and advance to “OFF-Delay.”   	<b>Light Operate</b> <ul style="list-style-type: none"> <li>• Display flashes “lo”</li> <li>• L icon</li> </ul> 
<b>Remote Input</b>	a. Double-pulse remote line to toggle between selections. b. Single-pulse remote line to save selection and advance to “OFF-Delay.”   	<b>Dark Operate</b> <ul style="list-style-type: none"> <li>• Display flashes “do”</li> <li>• D icon</li> </ul> 



3. Select OFF-Delay Timing Enable.

Method	Action	Result
Push Button	a. Click Dynamic (+) to toggle between selections. b. Click Static (-) to save selection and advance to "Display."	<p><b>Off (No OFF-Delay)</b></p> <ul style="list-style-type: none"> <li>"t 0"</li> <li>Clock icon OFF</li> </ul> 
Remote Input	a. Double-pulse remote line to toggle between selections. b. Single-pulse remote line to save selection and advance to "Display."	<p><b>2 to 100 ms OFF-Delay</b></p> <ul style="list-style-type: none"> <li>"t 2," "t 5," "t 10," "t 15," "t 20," "t 30," "t 40," "t 60," "t 80," or "t100"</li> <li>Clock icon ON</li> </ul> 

4. Select Display Parameters.

Method	Action	Result
Push Button	a. Click Dynamic (+) to toggle between selections. b. Click Static (-) to save selection and advance to "Power/Speed."	<p><b>Raw Signal Value</b></p>  <p>"1234"</p>
Remote Input	a. Double-pulse remote line to toggle between selections. b. Single-pulse remote line to save selection and advance to "Power/Speed."	<p><b>Percent of excess signal</b></p>  <p>"123P"</p>

5. Select Speed and Power Combination.

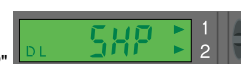
Method	Action	Result
Push Button	a. Click Dynamic (+) to toggle between selections. b. Click Static (-) to save selection and return to RUN mode. <b>OR</b> c. Press Static (-) four times to proceed to Advanced Setup.	<p>Indicator Arrow Icons 1 and 2 ON Red</p> <p><b>Super-high-speed (50-<math>\mu</math>s response)</b> "SHS" (Complementary outputs; see note below)</p>  <p><b>High-speed (200-<math>\mu</math>s response)</b> "HS"</p> 
Remote Input	a. Double pulse the remote line to toggle between selections. b. Single-pulse the remote line to save selection and return to RUN mode. <b>OR</b> c. Four-pulse the remote line to proceed to Advanced Setup.	<p><b>High-power (1-ms response)</b> "HP"</p>  <p><b>Super-high-power (2.5-ms response)</b> "SHP"</p>  <p><b>OR</b> See <a href="#">Advanced Setup</a> on page 10.</p>



**Super-High-Speed Operation Note:** Under most conditions, the sensor's two discrete outputs operate independently. However, the outputs become complementary when operating at Super-High-Speed, due to its extremely fast response time. Only channel 1 is taught/adjusted; channel 2 is complementary to it (output 1 conducts for the taught ON condition, and output 2 conducts for the OFF state). To invert these conditions (output 1 – OFF condition, output 2 – ON), change light/dark operate setting.



Advanced Setup

- Advanced adjustments to previously configured sensor display and operating parameters
- Quad-click Static (-) or quad-pulse remote line before exiting "Power and Speed" settings to enter this mode
- Click Dynamic (+) or double-pulse remote line to select an option

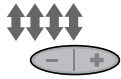
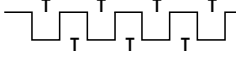

- Click Static or single-pulse remote line to advance
- Changes are updated instantly

The duration of each button click or remote input pulse is defined as T, where T is: 0.04 s < T < 0.8 s.



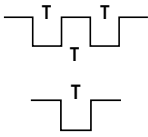
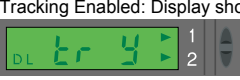

1. Enter SETUP Mode.

Method	Action	Result
Push Button	From the Power and Speed mode, quad-click the Static (-) button.	 <ul style="list-style-type: none"> <li>• Indicator Arrow Icons 1 and 2 remain red</li> <li>• Display shows "Tracking Enabled" option</li> </ul>
Remote Input	From the Power and Speed mode, quad-pulse the remote line.	 



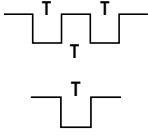

2. Set tracking, if desired.

Method	Action	Result
Push Button	a. Click Dynamic (+) to toggle between selections. b. Click Static (-) to save selection and advance to "Factory Default."	 <p><b>Sets output 2 identical to output 1</b> Tracking Disabled: Display shows "tr n"</p> 
Remote Input	a. Double-pulse the remote line to toggle between selections. b. Single-pulse the remote line to save selection and advance to "Factory Default."	 <p>Tracking Enabled: Display shows "tr Y"</p> 

3. Return the sensor to the factory default settings, if desired.

Method	Action	Result
Push Button	a. Click Dynamic (+) to toggle between selections. b. Click Static (-) to save selection and advance to "Display Orientation."	 <p><b>Returns to factory default factory settings</b> Factory Default Settings Not Selected: Display shows "Fd n"</p> 
Remote Input	a. Double-pulse the remote line to toggle between selections. b. Single-pulse the remote line to save selection and advance to "Display Orientation."	 <p>Factory Default Settings Selected: Display shows "Fd Y"</p> 

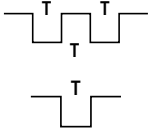

4. Change the display orientation, if desired.

Method	Action	Result
Push Button	a. Click Dynamic (+) to toggle between selections. b. Click Static (-) to return to RUN mode.	 <p><b>Inverts display to read "upside-down"</b> <b>Normal</b> For example: 1234 <b>Inverted</b> For example: 4E21</p> 
Remote Input	a. Double-pulse the remote line to toggle between selections. b. Single-pulse the remote line to return to RUN mode.	  <p> <b>Note:</b> Icons do not invert.</p>

Push Button Lockout

- Prevents unwanted adjustments or tampering of the push buttons
- Push buttons can be enabled or disabled only from the remote line and only during normal RUN mode

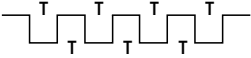
The duration of each button click or remote input pulse is defined as T, where T is: 0.04 s < T < 0.8 s.

Method	Action	Result
Push Button	Not available with push-button programming.	<p><b>Push buttons Disabled</b></p> <ul style="list-style-type: none"> <li>• Display flashes "loc"</li> <li>• Padlock icon appears</li> <li>• Sensor remains in RUN mode</li> </ul> 
Remote Input	<p>From RUN mode, quad-pulse the remote line to toggle between selections.</p> 	<p><b>Push Buttons Enabled</b></p> <ul style="list-style-type: none"> <li>• Display flashes "u loc"</li> <li>• Padlock icon disappears</li> <li>• Sensor remains in RUN mode</li> </ul> 

### Self-Diagnostic Error Modes

In the unlikely event that the setup parameters are lost or become corrupt, the display will continuously scroll: "USER PSF Error." Reteach the sensor to recover. If the problem persists, contact your Banner representative for further information.

### Gate Input

The pink wire is configured as a gate input. When this wire is pulled low (for example, to the sensor ground; 0–0.5 V dc), it inhibits the outputs from switching, while all other sensor functions continue to be enabled. This feature is useful for controlling when the outputs are allowed to change states. Gate input function response time is 1 millisecond.

## Specifications

#### Required Fiber-Optic Cable

Banner P-Series plastic fibers

#### Sensing Beam

Visible red, 680 nm or Visible green, 525 nm , depending on model

#### Supply Voltage and Current

12 to 24 V DC (10% maximum ripple) at less than 65 mA, exclusive of load

#### Supply Protection Circuitry

Protected against reverse polarity and transient voltages

#### Output Configuration

2 NPN or 2 PNP, depending on model

#### Output Rating

150 mA maximum load  
 OFF-state leakage current: < 10 µA at 24 V DC  
 ON-state saturation voltage:  
 NPN < 1.5 V at 150 mA load  
 PNP < 2.5 V at 150 mA load

#### Output Protection Circuitry

Protected against false pulse on power-up and continuous short-circuit

#### Output Response Time

Programmable, 50 microseconds, 200 microseconds, 1 millisecond, 2.5 milliseconds



**Note:** < 1 second delay on power-up; outputs do not conduct during this time.

#### Adjustments

Push-button or remote programming of response time, OFF-delay, light/dark operate, and display

#### Indicators

Four-digit digital display plus LED indicators for active channel, push-button lockout, OFF-delay and light/dark operate selection; two yellow output indicators

#### Construction

Black ABS/polycarbonate alloy (UL94 V-0 rated) housing, clear polycarbonate cover

#### Environmental Rating

NEMA 1, IP50

#### Connections

PVC-jacketed 2 m or 9 m (6.5 ft or 30 ft) 6-wire integral cable or integral 6-pin M8 quick-disconnect

#### Operating Conditions

**Temperature:** –20 °C to +55 °C (–4 °F to +131 °F)  
**Storage Temperature:** –20 °C to +80 °C (–4 °F to +176 °F)  
 90% at +50 °C maximum relative humidity (non-condensing)

Number of Devices, Stacked	Ambient Temperature Rating	Load Specification
3	55 °C	150 mA
7	50 °C	50 mA
10	45 °C	50 mA

#### Required Overcurrent Protection



**WARNING:** Electrical connections must be made by qualified personnel in accordance with local and national electrical codes and regulations.

Overcurrent protection is required to be provided by end product application per the supplied table. Overcurrent protection may be provided with external fusing or via Current Limiting, Class 2 Power Supply. Supply wiring leads < 24 AWG shall not be spliced. For additional product support, go to [www.bannerengineering.com](http://www.bannerengineering.com).

Supply Wiring (AWG)	Required Overcurrent Protection (Amps)
20	5.0
22	3.0
24	2.0
26	1.0
28	0.8
30	0.5

#### Certifications



## Dimensions

All measurements are listed in millimeters [inches], unless noted otherwise.

Figure 8. D10 dimensions

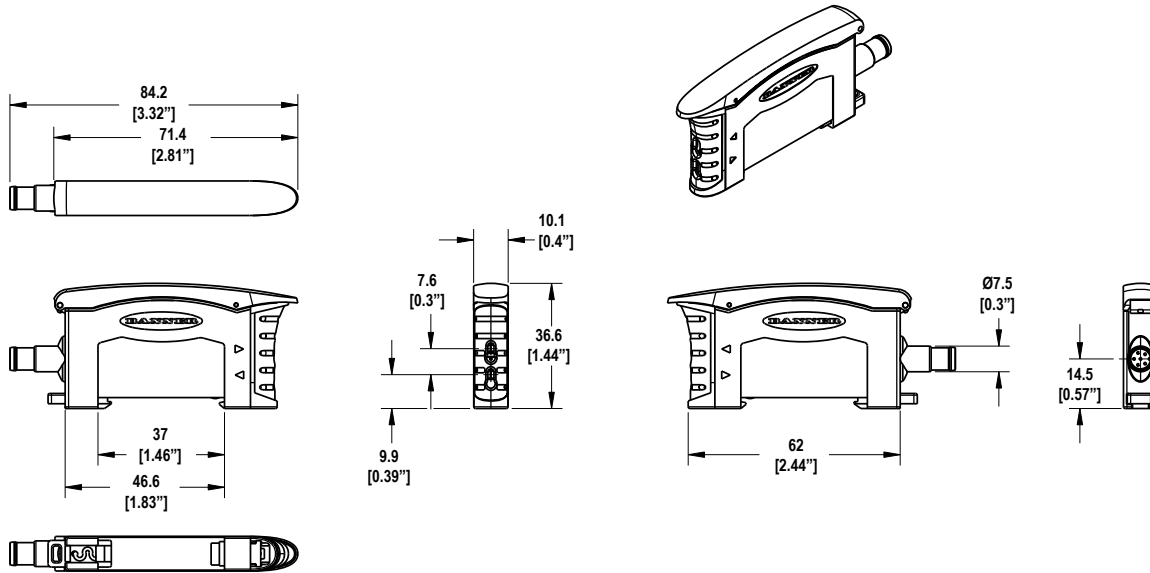
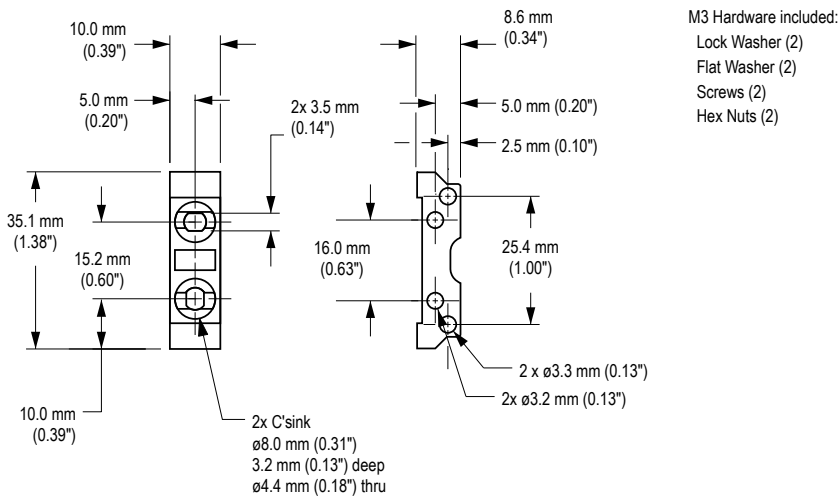

Figure 9. Included bracket dimensions



- M3 Hardware included:  
 Lock Washer (2)  
 Flat Washer (2)  
 Screws (2)  
 Hex Nuts (2)

## Accessories

6-Pin Snap-on M8 Cordsets—Single Ended				
Model	Length	Style	Dimensions	Pinout (Female)
PKG6Z-2	2 m (6.56 ft)	Straight		<p>1 - brown                      2 = White                      3 = Blue                      4 = Black                      5 = Gray                      6 = Pink</p>
PKG6Z-9	9 m (29.53 ft)			

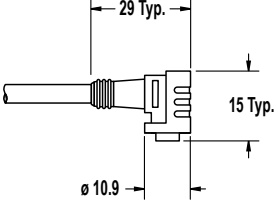
6-Pin Snap-on M8 Cordsets—Single Ended				
Model	Length	Style	Dimensions	Pinout (Female)
PKW6Z-2	2 m (6.56 ft)	Right-angle		
PKW6Z-9	9 m (29.53 ft)			

## Banner Engineering Corp. Limited Warranty

Banner Engineering Corp. warrants its products to be free from defects in material and workmanship for one year following the date of shipment. Banner Engineering Corp. will repair or replace, free of charge, any product of its manufacture which, at the time it is returned to the factory, is found to have been defective during the warranty period. This warranty does not cover damage or liability for misuse, abuse, or the improper application or installation of the Banner product.

**THIS LIMITED WARRANTY IS EXCLUSIVE AND IN LIEU OF ALL OTHER WARRANTIES WHETHER EXPRESS OR IMPLIED (INCLUDING, WITHOUT LIMITATION, ANY WARRANTY OF MERCHANTABILITY OR FITNESS FOR A PARTICULAR PURPOSE), AND WHETHER ARISING UNDER COURSE OF PERFORMANCE, COURSE OF DEALING OR TRADE USAGE.**

This Warranty is exclusive and limited to repair or, at the discretion of Banner Engineering Corp., replacement. **IN NO EVENT SHALL BANNER ENGINEERING CORP. BE LIABLE TO BUYER OR ANY OTHER PERSON OR ENTITY FOR ANY EXTRA COSTS, EXPENSES, LOSSES, LOSS OF PROFITS, OR ANY INCIDENTAL, CONSEQUENTIAL OR SPECIAL DAMAGES RESULTING FROM ANY PRODUCT DEFECT OR FROM THE USE OR INABILITY TO USE THE PRODUCT, WHETHER ARISING IN CONTRACT OR WARRANTY, STATUTE, TORT, STRICT LIABILITY, NEGLIGENCE, OR OTHERWISE.**

Banner Engineering Corp. reserves the right to change, modify or improve the design of the product without assuming any obligations or liabilities relating to any product previously manufactured by Banner Engineering Corp. Any misuse, abuse, or improper application or installation of this product or use of the product for personal protection applications when the product is identified as not intended for such purposes will void the product warranty. Any modifications to this product without prior express approval by Banner Engineering Corp will void the product warranties. All specifications published in this document are subject to change; Banner reserves the right to modify product specifications or update documentation at any time. Specifications and product information in English supersede that which is provided in any other language. For the most recent version of any documentation, refer to: [www.bannerengineering.com](http://www.bannerengineering.com).

For patent information, see [www.bannerengineering.com/patents](http://www.bannerengineering.com/patents).