

EZ-LIGHT® Touch Gen 2 K30 Series Illuminated Buttons

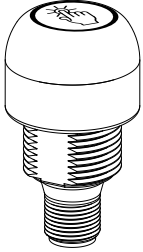

Datasheet

Lighted Touch Button with Bipolar Outputs



- Excellent immunity to false triggering by water spray, detergents, oils, and other foreign materials
- Rugged, cost-effective, and easy-to-install touch button with multicolor light
- Latching versions start up not activated and toggle between activated and not activated on successive touches
- Waterproof IP69K per DIN 40050-9 construction for washdown environments
- Ergonomically designed to eliminate hand, wrist, and arm stresses associated with repeated switch operation; requires no physical force to operate
- Can be actuated with bare hands or gloves
- 12 V DC to 30 V DC operation
- Five color options available
- Terminal connection models available for panel wiring applications

Models

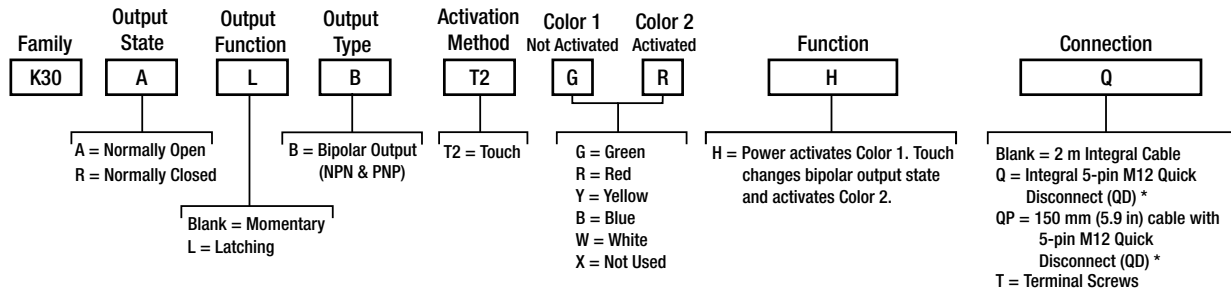

* QD model requires mating cordset

Sample Model	Description
K30ALBT2GRH	Normally open output state, latching output function with bipolar output and two touch activation method. Color 1: Green (not activated), Color 2: Red (activated). Power activates color 1. Touch changes bipolar output state and activates color 2. Two-meter integral cable connection.
K30ABT2XGHT	Normally open output state, momentary output function with bipolar output. Color 1: None, Color 2: Green (activated). Touch changes bipolar output state and activates color 2. Terminal screws.
K30RBT2RGHQ	Normally closed output state, momentary output function with bipolar output. Color 1: Red (not activated), Color 2: Green (activated). Touch changes bipolar output state and activates color 2. Integral 5-pin M12 quick disconnect connection.

Wiring Diagrams

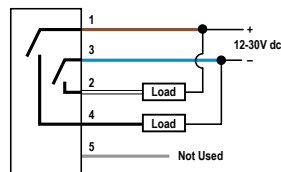

Color Key

- 1 = Brown
- 2 = White
- 3 = Blue
- 4 = Black
- 5 = Gray



Note: Cabled wiring diagrams are shown. Quick disconnect wiring diagrams are functionally identical.



Specifications

Supply Voltage

12 V DC to 30 V DC

Supply Current

55 mA max current (exclusive of load)

Supply Protection Circuitry

Protected against reverse polarity and transient voltages

Touch Dwell Time (momentary models only)

If a touch dwells for longer than 60 seconds, the output and indicator color will revert back to the untouched state.

Output Response Time

150 milliseconds ON and OFF

Output Rating

Maximum Load: 150 mA
ON-state saturation voltage: < 2 V DC at 10 mA; < 2.5 V DC at 150 mA
OFF-state leakage current: < 10 μ A at 30 V DC

Power-Up Delay

300 milliseconds
Latching models start up in a 'not activated' state

Mounting

M22 x 1.5 Threaded base, max torque 2.25 Nm (20 in-lbf)

Connections

5-pin integral M12 QD, 2 m (6.5 ft) PVC integral cable, or 150 mm (6 in) 5-pin M12 PVC cable with QD

Environmental Rating

Rated IEC IP67, and IP69K per DIN 40050-9.
Cabled models also meet IP69K if the cable and cable entrance are protected from high-pressure spray. Indicator side of terminal models meet IEC IP67, and IP69K when installed in an enclosure.
Screw connection points meet IEC IP00.
Meets UL type 4X and 13, when used in a suitable enclosure.

Operating Conditions

-40 °C to +50 °C (-40 °F to +122 °F)
90% at +50 °C maximum relative humidity (non-condensing)

Storage

-40 °C to +70 °C (-40 °F to +158 °F)

Vibration and Mechanical Shock

Vibration: 10 Hz to 55 Hz, 1.0 mm peak-to-peak amplitude per IEC 60068-2-6
Shock: 30G 11 ms duration, half sine wave per IEC 60068-2-27

Certifications



Construction

Housing: polycarbonate
Translucent dome: polycarbonate
Mounting nut: PBT

Indicator Characteristics

Color	Dominant Wavelength (nm) or Color Temperature (CCT)	Lumen Output (Typical at 25 °C)
Green	520 - 535 nm	4.4
Red	620 - 630 nm	1.7
Yellow	585 - 595 nm	4.4
Blue	465 - 475 nm	1.0
White	5665 - 9000K	5.0

Required Overcurrent Protection



WARNING: Electrical connections must be made by qualified personnel in accordance with local and national electrical codes and regulations.

Overcurrent protection is required to be provided by end product application per the supplied table.
Overcurrent protection may be provided with external fusing or via Current Limiting, Class 2 Power Supply.
Supply wiring leads < 24 AWG shall not be spliced.
For additional product support, go to www.bannerengineering.com.

Supply Wiring (AWG)	Required Overcurrent Protection (Amps)
20	5.0
22	3.0
24	2.0
26	1.0
28	0.8
30	0.5

Dimensions

All measurements are listed in millimeters [inches], unless noted otherwise.

Quick-Disconnect Models

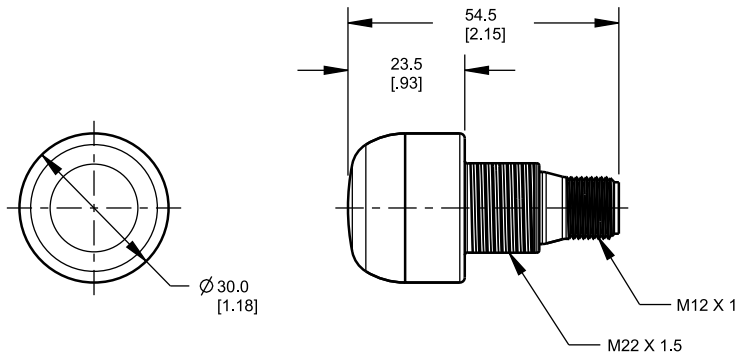

Terminal Models

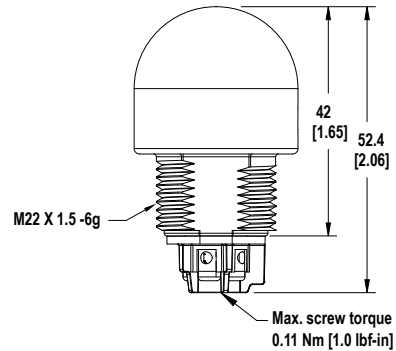

Accessories

Cordsets

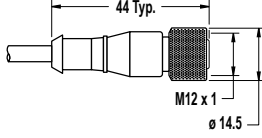
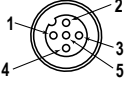
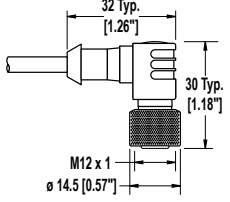
5-Pin Threaded M12 Cordsets—Single Ended				
Model	Length	Style	Dimensions	Pinout (Female)
MQDC1-501.5	0.5 m (1.5 ft)	Straight		 <p>1 = Brown 2 = White 3 = Blue 4 = Black 5 = Gray</p>
MQDC1-506	2 m (6.5 ft)			
MQDC1-515	5 m (16.4 ft)			
MQDC1-530	9 m (29.5 ft)	Right-Angle		
MQDC1-506RA	2 m (6.5 ft)			
MQDC1-515RA	5 m (16.4 ft)			
MQDC1-530RA	9 m (29.5 ft)			

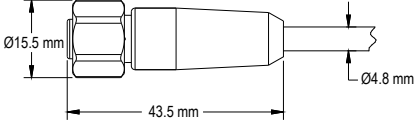
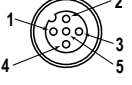
5-Pin Threaded M12 Stainless Steel Washdown Cordsets—Single Ended				
Model	Length	Style	Dimensions	Pinout (Female)
MQDC-WDSS-0506	2 m (6.56 ft)	Straight		 <p>1 = Brown 2 = White 3 = Blue 4 = Black 5 = Gray</p>
MQDC-WDSS-0515	5 m (16.4 ft)			
MQDC-WDSS-0530	9 m (29.5 ft)			

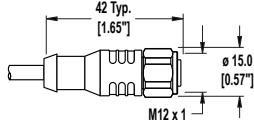
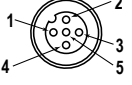
5-Pin Threaded M12 Washdown Cordsets with Shield—Single Ended				
Model	Length	Style	Dimensions	Pinout (Female)
MQDCWD-506	2 m (6.56 ft)	Straight		 <p>1 = Brown 2 = White 3 = Blue 4 = Black 5 = Gray</p>
MQDCWD-530	9 m (29.5 ft)			

Brackets

SMB22A

- Right-angle bracket with curved slot for versatile orientation
- 12-ga. stainless steel
- Mounting hole for 22 mm sensor

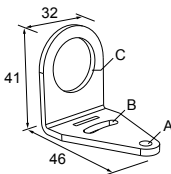

Hole center spacing: A to B = 26.0
Hole size: A = ø 4.6, B = 4.6 x 16.9, C = 22.2

SMB22FVK

- V-clamp, flat bracket and fasteners for mounting to pipe or extensions
- Clamp accommodates 28 mm diameter tubing or 1 in. square extrusions
- 22 mm hole for mounting sensor

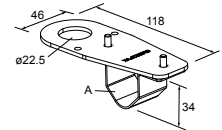

Hole size: A = ø 22.5

SMB22RAVK

- V-clamp, right-angle bracket and fasteners for mounting to pipe or extensions
- Clamp accommodates 28 mm diameter tubing or 1 in. square extrusions
- 22 mm hole for mounting sensor

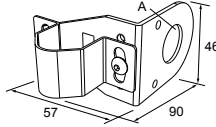

Hole size: A = ϕ 22.5

SMBAMS22P

- Flat SMBAMS series bracket with 22 mm hole for mounting sensors
- Articulation slots for 90+° rotation
- 12-ga. (2.6 mm) cold-rolled steel

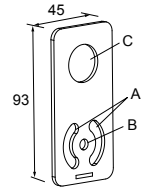

Hole center spacing: A = 26.0, A to B = 13.0

Hole size: A = 26.8 x 7.0, B = ϕ 6.5, C = ϕ 22.5

SMBAMS22RA

- Right-angle SMBAMS series bracket with 22 mm hole for mounting sensors
- Articulation slots for 90+° rotation
- 12-ga. (2.6 mm) cold-rolled steel

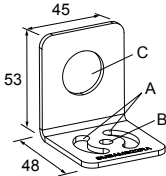

Hole center spacing: A = 26.0, A to B = 13.0

Hole size: A = 26.8 x 7.0, B = ϕ 6.5, C = ϕ 22.5

TC-K30-CL

- Touch cover

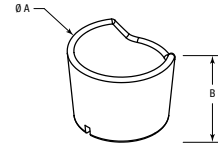

Diameter: A = 40.7

Height: B = 31

All measurements are listed in millimeters, unless noted otherwise.

Banner Engineering Corp. Limited Warranty

Banner Engineering Corp. warrants its products to be free from defects in material and workmanship for one year following the date of shipment. Banner Engineering Corp. will repair or replace, free of charge, any product of its manufacture which, at the time it is returned to the factory, is found to have been defective during the warranty period. This warranty does not cover damage or liability for misuse, abuse, or the improper application or installation of the Banner product.

THIS LIMITED WARRANTY IS EXCLUSIVE AND IN LIEU OF ALL OTHER WARRANTIES WHETHER EXPRESS OR IMPLIED (INCLUDING, WITHOUT LIMITATION, ANY WARRANTY OF MERCHANTABILITY OR FITNESS FOR A PARTICULAR PURPOSE), AND WHETHER ARISING UNDER COURSE OF PERFORMANCE, COURSE OF DEALING OR TRADE USAGE.

This Warranty is exclusive and limited to repair or, at the discretion of Banner Engineering Corp., replacement. **IN NO EVENT SHALL BANNER ENGINEERING CORP. BE LIABLE TO BUYER OR ANY OTHER PERSON OR ENTITY FOR ANY EXTRA COSTS, EXPENSES, LOSSES, LOSS OF PROFITS, OR ANY INCIDENTAL, CONSEQUENTIAL OR SPECIAL DAMAGES RESULTING FROM ANY PRODUCT DEFECT OR FROM THE USE OR INABILITY TO USE THE PRODUCT, WHETHER ARISING IN CONTRACT OR WARRANTY, STATUTE, TORT, STRICT LIABILITY, NEGLIGENCE, OR OTHERWISE.**

Banner Engineering Corp. reserves the right to change, modify or improve the design of the product without assuming any obligations or liabilities relating to any product previously manufactured by Banner Engineering Corp. Any misuse, abuse, or improper application or installation of this product or use of the product for personal protection applications when the product is identified as not intended for such purposes will void the product warranty. Any modifications to this product without prior express approval by Banner Engineering Corp will void the product warranties. All specifications published in this document are subject to change; Banner reserves the right to modify product specifications or update documentation at any time. Specifications and product information in English supersede that which is provided in any other language. For the most recent version of any documentation, refer to: www.bannerengineering.com.

For patent information, see www.bannerengineering.com/patents.

FCC Part 15 and CAN ICES-3 (B)/NMB-3(B)

This device complies with part 15 of the FCC Rules and CAN ICES-3 (B)/NMB-3(B). Operation is subject to the following two conditions:

1. This device may not cause harmful interference, and
2. This device must accept any interference received, including interference that may cause undesired operation.

This equipment has been tested and found to comply with the limits for a Class B digital device, pursuant to part 15 of the FCC Rules and CAN ICES-3 (B)/NMB-3(B). These limits are designed to provide reasonable protection against harmful interference in a residential installation. This equipment generates, uses and can radiate radio frequency energy and, if not installed and used in accordance with the instructions, may cause harmful interference to radio communications. However, there is no guarantee that interference will not occur in a particular installation. If this equipment does cause harmful interference to radio or television reception, which can be determined by turning the equipment off and on, the user is encouraged to try to correct the interference by one or more of the following measures:

- Reorient or relocate the receiving antenna.
- Increase the separation between the equipment and receiver.
- Connect the equipment into an outlet on a circuit different from that to which the receiver is connected.
- Consult the manufacturer.