

# EZ-LIGHT® K50L Sealed Audible Indicators



## Datasheet

DC-Operated Indicators with Steady or Pulsed Sound Indication

To view or download the latest technical information about this product, including specifications, dimensions, accessories, and wiring, see [www.bannerengineering.com](http://www.bannerengineering.com).



- Rugged, cost-effective, and easy-to-install bright indicators with audible alarm
- Fully sealed and rated at IP67 or IP69K per DIN 40050-9, depending on model
- Compact devices are completely self-contained, no controller needed
- Immune to EMI and RFI interference
- Loud audible alarm with intensity adjustment (IEC IP67 models)
- 12 V dc to 30 V dc operation
- Available in continuous and staccato tones (IP67 models)



### WARNING: Not To Be Used for Personnel Protection

Never use this device as a sensing device for personnel protection. Doing so could lead to serious injury or death. This device does not include the self-checking redundant circuitry necessary to allow its use in personnel safety applications. A sensor failure or malfunction can cause either an energized or de-energized sensor output condition.

## Models

Model	LED Function <sup>1</sup>	Input	Audible Tone†	Connection <sup>2</sup>
<b>Fixed Audible Sealed Models</b>				
K50LGXASXPQ	1 Color: Green	PNP	Fixed tone volume	5-pin M12/Euro-style quick disconnect (QD)
K50LGRASXPQ	2 Color: Green, Red			
K50LGRASYPQ	3 Color: Green, Red, Yellow			
K50LGXASXNQ	1 Color: Green	NPN		
K50LGRASXNQ	2 Color: Green, Red			
K50LGRASYNQ	3 Color: Green, Red, Yellow			
<b>Adjustable Loud Audible Sealed Models</b>				
K50LGXALSXPQ	1 Color: Green	PNP	Continuous tone with volume adjustment	5-pin M12/Euro-style quick disconnect (QD)
K50LGRALSXPQ	2 Color: Green, Red			
K50LGRALSYPQ	3 Color: Green, Red, Yellow			
K50LGXALSXNQ	1 Color: Green	NPN		
K50LGRALSXNQ	2 Color: Green, Red			
K50LGRALSYNQ	3 Color: Green, Red, Yellow			
K50LGXALS4XPQ	1 Color: Green	PNP	Staccato tone with volume adjustment	
K50LGRALS4XPQ	2 Color: Green, Red			
K50LGRALS4YPQ	3 Color: Green, Red, Yellow			
K50LGXALS4XNQ	1 Color: Green	NPN		
K50LGRALS4XNQ	2 Color: Green, Red			
K50LGRALS4YNQ	3 Color: Green, Red, Yellow			

## Installation in Very Wet Environments

For best sound quality and volume when mounting an IP67 audible indicator model in an extremely wet environment, consider the mounting orientation. Mount the indicator horizontally or facing downward to allow water to drain easily. Upright mounting will allow water to collect in the alarm cavity, which will muffle the sound.

<sup>1</sup> Contact Banner Engineering for other colors and color combinations.

<sup>2</sup> Integral 5-pin M12/Euro-style quick disconnect models are listed.

- To order the 150 mm (6 in) PVC cable model, replace the suffix "Q" with "QP" in the model number. For example, K50LGXASXPQP.
- To order the 2 m (6.5 ft) PVC cable model, omit the suffix "Q" in the model number. For example, K50LGXASXP.
- Models with a quick disconnect require a mating cordset.



## Wiring Diagrams

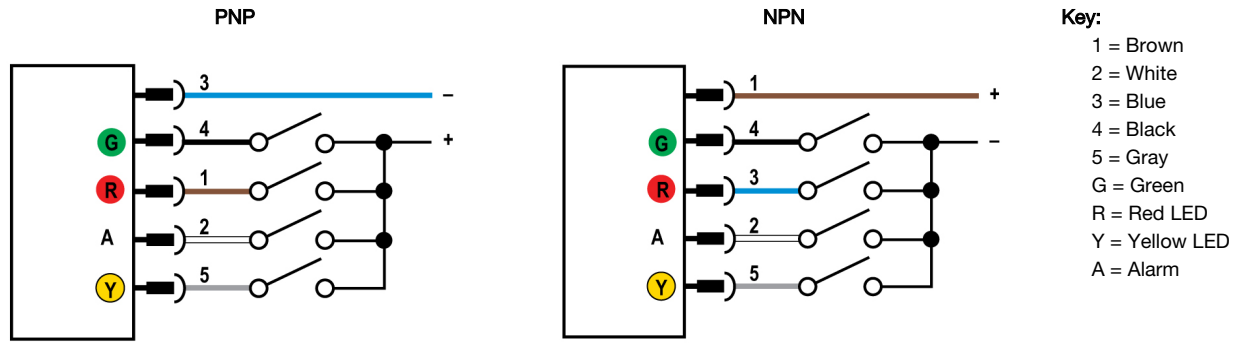

**Note:** When fewer than three LED colors are used, the corresponding wires are unused.

## Specifications

### Supply Voltage and Current

12 V dc to 30 V dc  
65 mA at 12 V dc; 35 mA at 30 V dc maximum current per LED  
Audible: 35 mA maximum current

### Supply Protection Circuitry

Protected against reverse polarity and transient voltages

### Input Response Time

Indicator ON/OFF: 1 ms maximum  
Audible ON/OFF: 10 ms maximum

### Audible Alarm

**IP67 Models:** 2.9 kHz ± 250 Hz oscillation frequency; max. intensity 94 db at 1 m (3.3 ft) (typical)  
**IP69K Models:** 2.9 kHz ± 250 Hz oscillation frequency; max. intensity 65 db at 1 m (3.3) (typical)

### Vibration and Mechanical Shock

All models meet MIL-STD-202F, Method 201A (Vibration: 10 Hz to 60 Hz maximum, 0.06 inch (1.52 mm) double amplitude, 10G maximum acceleration) requirements. Also meets IEC 60947-5-2 (Shock: 30G 11 ms duration, half sine wave) requirements.

### Environmental Rating

**Fixed Audible Sealed Models:** IEC IP67/IP69K per DIN 40050-9  
**Adjustable Loud Audible Sealed Models:** IEC IP67  
NEMA/UL Type 4X, 13

### Operating Conditions

-20 °C to +50 °C (-4 °F to +122 °F)  
95% maximum relative humidity (non-condensing)

### Certifications



### Audible Adjustment

Rotate the front cover until the desired intensity is achieved (IEC IP67 models only)

### Connections

Integral 5-pin M12/Euro-style quick disconnect or 2 m (6.5 ft) integral cable, depending on model

### Construction

**Fixed Audible Sealed Models:** Polycarbonate housing and audible alarm  
**Adjustable Loud Audible Sealed Models:** Polycarbonate housing and PPO audible alarm

### Required Overcurrent Protection



**WARNING:** Electrical connections must be made by qualified personnel in accordance with local and national electrical codes and regulations.

Overcurrent protection is required to be provided by end product application per the supplied table. Overcurrent protection may be provided with external fusing or via Current Limiting, Class 2 Power Supply. Supply wiring leads < 24 AWG shall not be spliced. For additional product support, go to [www.bannerengineering.com](http://www.bannerengineering.com).

Supply Wiring (AWG)	Required Overcurrent Protection (Amps)
20	5.0
22	3.0
24	2.0
26	1.0
28	0.8
30	0.5

## Dimensions

### Cabled Dimensions

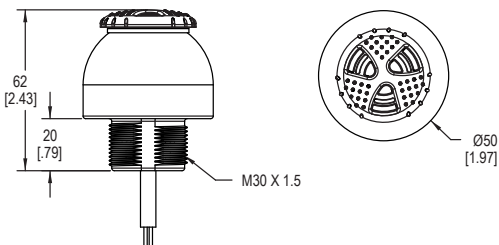

### QD Dimensions

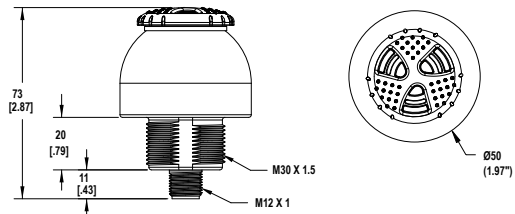

## Accessories

### 5-Pin Euro-Style Cordsets

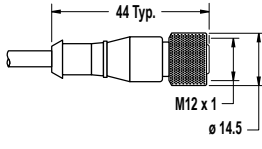
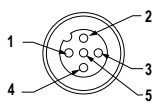
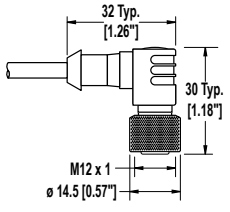
5-Pin Threaded M12/Euro-Style Cordsets—Single Ended				
Model	Length	Style	Dimensions	Pinout (Female)
MQDC1-501.5	0.50 m (1.5 ft)	Straight		 <p>1 = Brown 2 = White 3 = Blue 4 = Black 5 = Gray</p>
MQDC1-506	1.83 m (6 ft)			
MQDC1-515	4.57 m (15 ft)			
MQDC1-530	9.14 m (30 ft)	Right-Angle		
MQDC1-506RA	1.83 m (6 ft)			
MQDC1-515RA	4.57 m (15 ft)			
MQDC1-530RA	9.14 m (30 ft)			

## Mounting Brackets

### SMB30A

- Right-angle bracket with curved slot for versatile orientation
- Clearance for M6 (¼ in) hardware
- Mounting hole for 30 mm sensor
- 12-ga. stainless steel

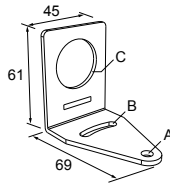

**Hole center spacing:** A to B=40  
**Hole size:** A=ø 6.3, B= 27.1 x 6.3, C=ø 30.5

### SMB30FA

- Swivel bracket with tilt and pan movement for precise adjustment
- Mounting hole for 30 mm sensor
- 12-ga. 304 stainless steel
- Easy sensor mounting to extrude rail T-slot
- Metric and inch size bolt available

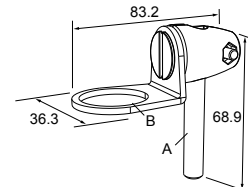

**Bolt thread:** SMB30FA, A= 3/8 - 16 x 2 in; SMB30FAM10, A= M10 - 1.5 x 50  
**Hole size:** B= ø 30.1

### SMB30MM

- 12-ga. stainless steel bracket with curved mounting slots for versatile orientation
- Clearance for M6 (¼ in) hardware
- Mounting hole for 30 mm sensor

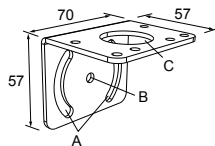

**Hole center spacing:** A = 51, A to B = 25.4  
**Hole size:** A = 42.6 x 7, B = ø 6.4, C = ø 30.1

### SMB30SC

- Swivel bracket with 30 mm mounting hole for sensor
- Black reinforced thermoplastic polyester
- Stainless steel mounting and swivel locking hardware included

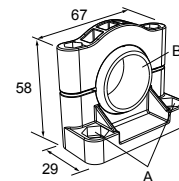

**Hole center spacing:** A=ø 50.8  
**Hole size:** A=ø 7.0, B=ø 30.0

### SMB30SK

- Flat-mount swivel bracket with extended range of motion
- Black reinforced thermoplastic polyester and 316 stainless steel
- Stainless steel swivel locking hardware included

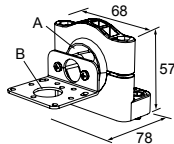

**Hole center spacing:** A = 50.8  
**Hole size:** A = ø 7, B = ø 18

### LMBE12RA35

- Direct mounting of stand-off pipe, with common bracket type
- Zinc-plated steel
- 1/2-14 NPSM nut
- Mounting distance from the wall to the center of the 1/2-14 NPSM nut is 35 mm

Hole center spacing: 20.0

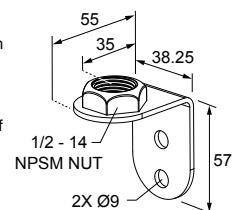

**LMBE12RA45**

- Direct mounting of stand-off pipe, with common bracket type
- Zinc-plated steel
- 1/2-14 NPSM nut
- Mounting distance from the wall to the center of the 1/2-14 NPSM nut is 45 mm

Hole center spacing: 35.0

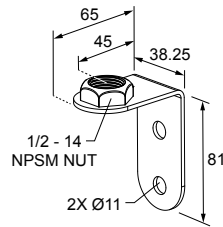

## Elevated Mount System

Model	Features			Components												
<b>SA-M30E12</b> - Black Acetal	<ul style="list-style-type: none"> <li>• Streamlined black acetal stand-off pipe adapter/cover</li> <li>• Connects between 30 mm light base and ½ in. NPSM/DN15 pipe</li> <li>• Mounting hardware included</li> </ul>															
<table border="1"> <thead> <tr> <th>Polished 304 Stainless Steel</th> <th>Black Anodized Aluminum</th> <th>Clear Anodized Aluminum</th> </tr> </thead> <tbody> <tr> <td><b>SOP-E12-150SS</b> 150 mm (6 in) long</td> <td><b>SOP-E12-150A</b> 150 mm (6 in) long</td> <td><b>SOP-E12-150AC</b> 150 mm (6 in) long</td> </tr> <tr> <td><b>SOP-E12-300SS</b> 300 mm (12 in) long</td> <td><b>SOP-E12-300A</b> 300 mm (12 in) long</td> <td><b>SOP-E12-300AC</b> 300 mm (12 in) long</td> </tr> <tr> <td><b>SOP-E12-900SS</b> 900 mm (36 in) long</td> <td><b>SOP-E12-900A</b> 900 mm (36 in) long</td> <td><b>SOP-E12-900AC</b> 900 mm (36 in) long</td> </tr> </tbody> </table>	Polished 304 Stainless Steel	Black Anodized Aluminum	Clear Anodized Aluminum	<b>SOP-E12-150SS</b> 150 mm (6 in) long	<b>SOP-E12-150A</b> 150 mm (6 in) long	<b>SOP-E12-150AC</b> 150 mm (6 in) long	<b>SOP-E12-300SS</b> 300 mm (12 in) long	<b>SOP-E12-300A</b> 300 mm (12 in) long	<b>SOP-E12-300AC</b> 300 mm (12 in) long	<b>SOP-E12-900SS</b> 900 mm (36 in) long	<b>SOP-E12-900A</b> 900 mm (36 in) long	<b>SOP-E12-900AC</b> 900 mm (36 in) long	<ul style="list-style-type: none"> <li>• Elevated-use stand-off pipe (½ in. NPSM/DN15)</li> <li>• Polished 304 stainless steel, black anodized aluminum, or clear anodized aluminum surface</li> <li>• ½ in. NPT thread at both ends</li> <li>• Compatible with most industrial environments</li> </ul>			
Polished 304 Stainless Steel	Black Anodized Aluminum	Clear Anodized Aluminum														
<b>SOP-E12-150SS</b> 150 mm (6 in) long	<b>SOP-E12-150A</b> 150 mm (6 in) long	<b>SOP-E12-150AC</b> 150 mm (6 in) long														
<b>SOP-E12-300SS</b> 300 mm (12 in) long	<b>SOP-E12-300A</b> 300 mm (12 in) long	<b>SOP-E12-300AC</b> 300 mm (12 in) long														
<b>SOP-E12-900SS</b> 900 mm (36 in) long	<b>SOP-E12-900A</b> 900 mm (36 in) long	<b>SOP-E12-900AC</b> 900 mm (36 in) long														
<b>SA-E12M30</b> - Black Acetal	<ul style="list-style-type: none"> <li>• Streamlined black acetal mounting base adapter/cover</li> <li>• Connects between ½ in. NPSM/DN15 pipe and 30 mm (1-3/16 in) drilled hole</li> <li>• Mounting hardware included</li> </ul>															

## Banner Engineering Corp. Limited Warranty

Banner Engineering Corp. warrants its products to be free from defects in material and workmanship for one year following the date of shipment. Banner Engineering Corp. will repair or replace, free of charge, any product of its manufacture which, at the time it is returned to the factory, is found to have been defective during the warranty period. This warranty does not cover damage or liability for misuse, abuse, or the improper application or installation of the Banner product.

**THIS LIMITED WARRANTY IS EXCLUSIVE AND IN LIEU OF ALL OTHER WARRANTIES WHETHER EXPRESS OR IMPLIED (INCLUDING, WITHOUT LIMITATION, ANY WARRANTY OF MERCHANTABILITY OR FITNESS FOR A PARTICULAR PURPOSE), AND WHETHER ARISING UNDER COURSE OF PERFORMANCE, COURSE OF DEALING OR TRADE USAGE.**

This Warranty is exclusive and limited to repair or, at the discretion of Banner Engineering Corp., replacement. **IN NO EVENT SHALL BANNER ENGINEERING CORP. BE LIABLE TO BUYER OR ANY OTHER PERSON OR ENTITY FOR ANY EXTRA COSTS, EXPENSES, LOSSES, LOSS OF PROFITS, OR ANY INCIDENTAL, CONSEQUENTIAL OR SPECIAL DAMAGES RESULTING FROM ANY PRODUCT DEFECT OR FROM THE USE OR INABILITY TO USE THE PRODUCT, WHETHER ARISING IN CONTRACT OR WARRANTY, STATUTE, TORT, STRICT LIABILITY, NEGLIGENCE, OR OTHERWISE.**

Banner Engineering Corp. reserves the right to change, modify or improve the design of the product without assuming any obligations or liabilities relating to any product previously manufactured by Banner Engineering Corp. Any misuse, abuse, or improper application or installation of this product or use of the product for personal protection applications when the product is identified as not intended for such purposes will void the product warranty. Any modifications to this product without prior express approval by Banner Engineering Corp will void the product warranties. All specifications published in this document are subject to change. Banner reserves the right to modify product specifications or update documentation at any time. Specifications and product information in English supersedes that which is provided in any other language. For the most recent version of any documentation, refer to: [www.bannerengineering.com](http://www.bannerengineering.com).

For patent information, see [www.bannerengineering.com/patents](http://www.bannerengineering.com/patents).

## FCC Part 15 and CAN ICES-3 (B)/NMB-3(B)

This device complies with part 15 of the FCC Rules and CAN ICES-3 (B)/NMB-3(B). Operation is subject to the following two conditions:

1. This device may not cause harmful interference, and
2. This device must accept any interference received, including interference that may cause undesired operation.

This equipment has been tested and found to comply with the limits for a Class B digital device, pursuant to part 15 of the FCC Rules and CAN ICES-3 (B)/NMB-3(B). These limits are designed to provide reasonable protection against harmful interference in a residential installation. This equipment generates, uses and can radiate radio frequency energy and, if not installed and used in accordance with the instructions, may cause harmful interference to radio communications. However, there is no guarantee that interference will not occur in a particular installation. If this equipment does cause harmful interference to radio or television reception, which can be determined by turning the equipment off and on, the user is encouraged to try to correct the interference by one or more of the following measures:

- Reorient or relocate the receiving antenna.
- Increase the separation between the equipment and receiver.
- Connect the equipment into an outlet on a circuit different from that to which the receiver is connected.
- Consult the manufacturer.