

R-GAGE® K50R Radar Sensor

Instruction Manual

Original Instructions
226219 Rev. C
2 June 2022
© Banner Engineering Corp. All rights reserved



226219

Contents

1 Product Description	3
1.1 Models	3
1.2 Overview	3
1.3 Features and Indicators	4
2 Installation Instructions	5
2.1 Install the Software	5
2.2 Sensor Orientation	5
2.3 Mount the Device	5
2.4 Connect to the Sensor	6
2.5 Wiring	6
3 Getting Started	7
3.1 Connect to the Sensor	7
3.2 Software Overview	7
4 Banner Radar Configuration Workspace	8
4.1 Navigation Toolbar	8
4.2 Live Sensor Data and Legend	8
4.3 Summary Pane	9
4.4 Sensor Settings Pane	9
4.4.1 General Tab	9
4.4.2 Discrete 1 Tab	10
4.4.3 Discrete 2 Tab	10
4.4.4 Indication Tab	11
4.5 Live Sensor Data Controls	11
5 Configuring a Sensor	12
5.1 Banner Radar Configuration Software	12
5.2 Remote Input	12
5.2.1 Remote Teach	14
5.2.2 Remote Setup	14
5.3 Reset the Sensor to Factory Defaults	16
5.3.1 Factory Default Settings	17
5.4 Using Measurement Hold Example	18
6 Configure a Pro Sensor	19
6.1 Distance Mode	20
6.2 Four State Mode	21
6.3 Enable/Disable the LEDs	21
7 Specifications	22
7.1 FCC Part 15 Class A	23
7.2 Industry Canada	23
7.3 PC Requirements	23
7.4 Dimensions	23
7.5 Beam Patterns	24
8 Update the Software	25
9 Accessories	26
9.1 Cordsets	26
9.2 Configuration Tools	26
10 Product Support and Maintenance	27
10.1 Repairs	27
10.2 Contact Us	27
10.3 Banner Engineering Corp. Software Copyright Notice	27
10.4 Banner Engineering Corp. Limited Warranty	27

1 Product Description

Radar-Based Sensors for Detection and Measurement of Moving and Stationary Targets. Patent pending.



- Pulsed coherent radar (PCR) detects moving and stationary objects
- Bright, visible indication; available in Pro models with configurable LEDs
- Adjustable sensing field—ignores objects beyond setpoint
- Easy setup and configuration of range, sensitivity, and output using the Banner Radar Configuration Software
- Sensing functions are immune to wind, fog, steam, and temperature changes and resistant to rain and snow
- Compact, rugged IP67 housing withstands harsh environments



WARNING:

- **Do not use this device for personnel protection**
- Using this device for personnel protection could result in serious injury or death.
- This device does not include the self-checking redundant circuitry necessary to allow its use in personnel safety applications. A device failure or malfunction can cause either an energized (on) or de-energized (off) output condition.

1.1 Models

Models	Type	Beam Pattern	Range	Connection	Supply Voltage	Telecom Approved	Output
K50RF-8060-LDQ	Standard	80 × 60 degrees	100 mm to 2.5 m (3.9 in to 8.2 ft)	Integral M12 quick disconnect	10 V DC to 30 V DC	Telecom approved for US, Canada, Europe, UK, and Australia/New Zealand	Dual discrete (NPN/PNP) Pulse Pro
K50RPF-8060-LDQ	Pro with configurable LEDs						

1.2 Overview

The K50R is an industrial radar sensor that uses high frequency radio waves from an internal antenna.

The K50R detects a wide variety of materials including metal, water, or organic materials. Configure the sensor using software or remote input wires to sense objects up to a specific distance, ignoring objects beyond this distance (background suppression). Or teach the sensor a reference point to detect the presence or absence of an objects (retroreflective).

Figure 1. Sensing Range

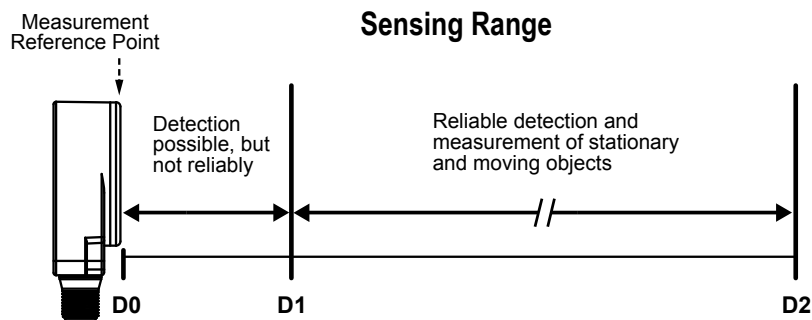

Model	D0 (m)	D1 (m)	D2 (m)
K50RxF-8060-LDQ	0	0.1	2.5

1.3 Features and Indicators





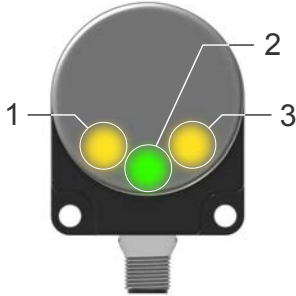

K50R Standard—Features

Figure 2. K50RF-8060-LDQ Features



	LED	Color	Description
1	Output 1	Amber	Discrete output status
2	Power/Signal Strength	Green or Blue	Power ON and signal strength indication
3	Output 2	Amber	Discrete output status

K50R Standard—Signal Strength and the Indicator LEDs

LED	Color	Description	LED	Color	Description
	ON Green	Power ON Signal strength is greater than 2x the user-selected threshold		ON Amber	Discrete output 1 status
	Flashing Green	Power ON Signal strength is less than 2x the user-selected threshold		ON Amber	Discrete output 2 status
	ON Blue	Power ON Signal strength is less than 1		Flashing Red	Error

K50R Pro—Features

Figure 3. K50RPF-8060-LDQ Features



The Pro models offer advanced indication of distance thresholds and device states. Options include animation, intensity, patterns, colors, and others.

See [Configure a Pro Sensor](#) on page 19 for configuration information and instructions.

If all LEDs flash red continually, the sensor is in an error state.

2 Installation Instructions

2.1 Install the Software



Important: Administrative rights are required to install the Banner Radar Configuration software.

1. Download the latest version of the software from www.bannerengineering.com/us/en/products/sensors/software/radar-configuration.html.
2. Navigate to and open the downloaded file.
3. Click **Install** to begin the installation process.
4. Depending on your system settings, a popup window may appear prompting to allow Banner Radar Configuration to make changes to your computer. Click **Yes**.
5. Click **Close** to exit the installer.

2.2 Sensor Orientation

Correct sensor-to-object orientation is important to ensure proper sensing.

Minimize the tilt angle of a target relative to the sensor. The target should be tilted less than half of the beam angle.

Figure 4. Tilt angle of the target relative to the sensor

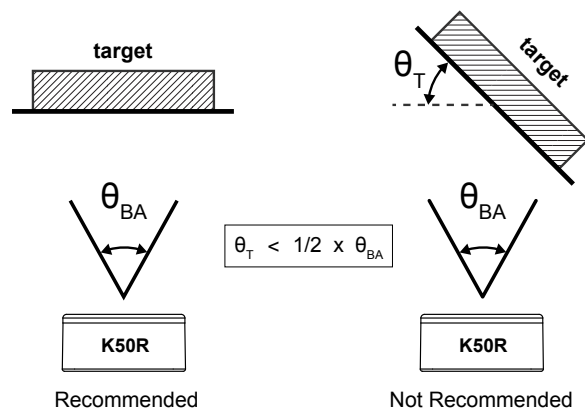

2.3 Mount the Device

1. If a bracket is needed, mount the device onto the bracket.
2. Mount the device (or the device and the bracket) to the machine or equipment at the desired location. Do not tighten the mounting screws at this time.
3. Check the device alignment.
4. Tighten the mounting screws to secure the device (or the device and the bracket) in the aligned position.

2.4 Connect to the Sensor

Figure 5. System Components for a Typical Installation

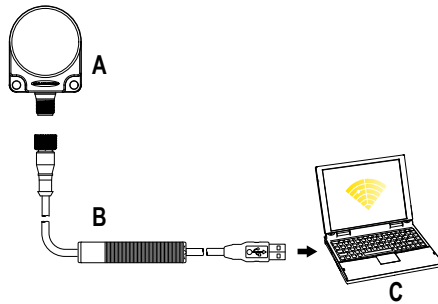

- A = K50R
- B = Pro Converter Cable (MQDC-506-USB)
- C = PC running Banner Radar Configuration software



Note: Requires a PC USB port to supply 0.5 A at 5 V.

Figure 6. Alternative System Components

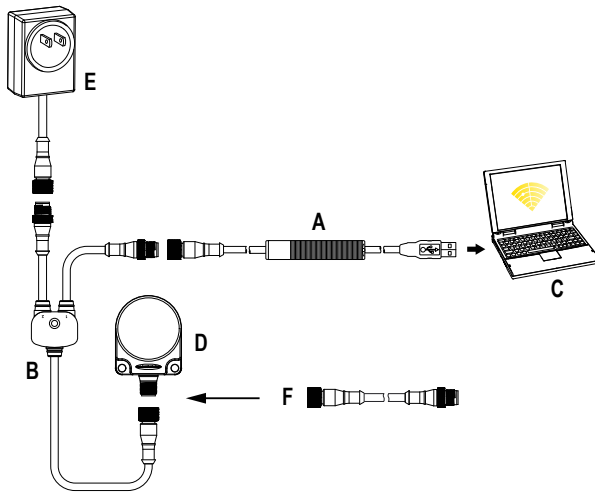

- A = Pro Converter Cable (MQDC-506-USB)
- B = Splitter (CSB-M1251FM1251M)
- C = PC running Banner Radar Configuration software
- D = K50R
- E = Power Supply (PSW-24-1 or PSD-24-4)
- F = Optional 5-Pin to 5-Pin Double-Ended Cordset (ex. MQDEC3-515SS)



Note: Recommended when a PC USB Type A supplies less than 0.5 A at 5 V.

2.5 Wiring

Quick disconnect wiring diagrams are functionally identical.

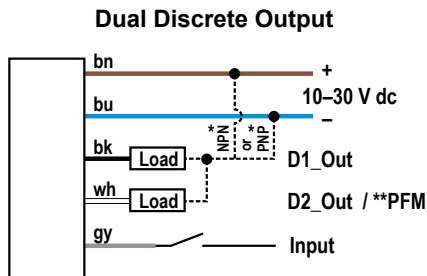

* Push-Pull output. User-configurable PNP/NPN setting.
 ** Pulse Frequency Modulation

Key:

- 1 = Brown
- 2 = White
- 3 = Blue
- 4 = Black
- 5 = Gray (Connect for use with remote input or Banner Radar Configuration software)

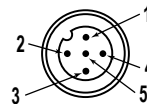

Note: A shielded cable is required if the sensor is mounted outdoors or if the cable is longer than 30 m (98.4 ft).

3 Getting Started

Power up the sensor, and verify that the power LED is ON green.

3.1 Connect to the Sensor

1. Connect the sensor to the Pro Cable. See [Configuration Tools](#) on page 26.
2. Connect the Pro Converter cable to the PC.
3. Open the Banner Radar Configuration Software.
4. Go to **Sensor > Connect** on the **Navigation** toolbar. The **Connection** screen displays.
5. Select the correct **Sensor Model** and **Com Port** for the sensor.
6. Click **Connect**. The **Connection** screen closes and the sensor data displays.

3.2 Software Overview

Easy setup and configuration of range, sensitivity, and output using the Banner Radar Configuration software and Pro Converter Cable.

Figure 7. Banner Radar Configuration Software

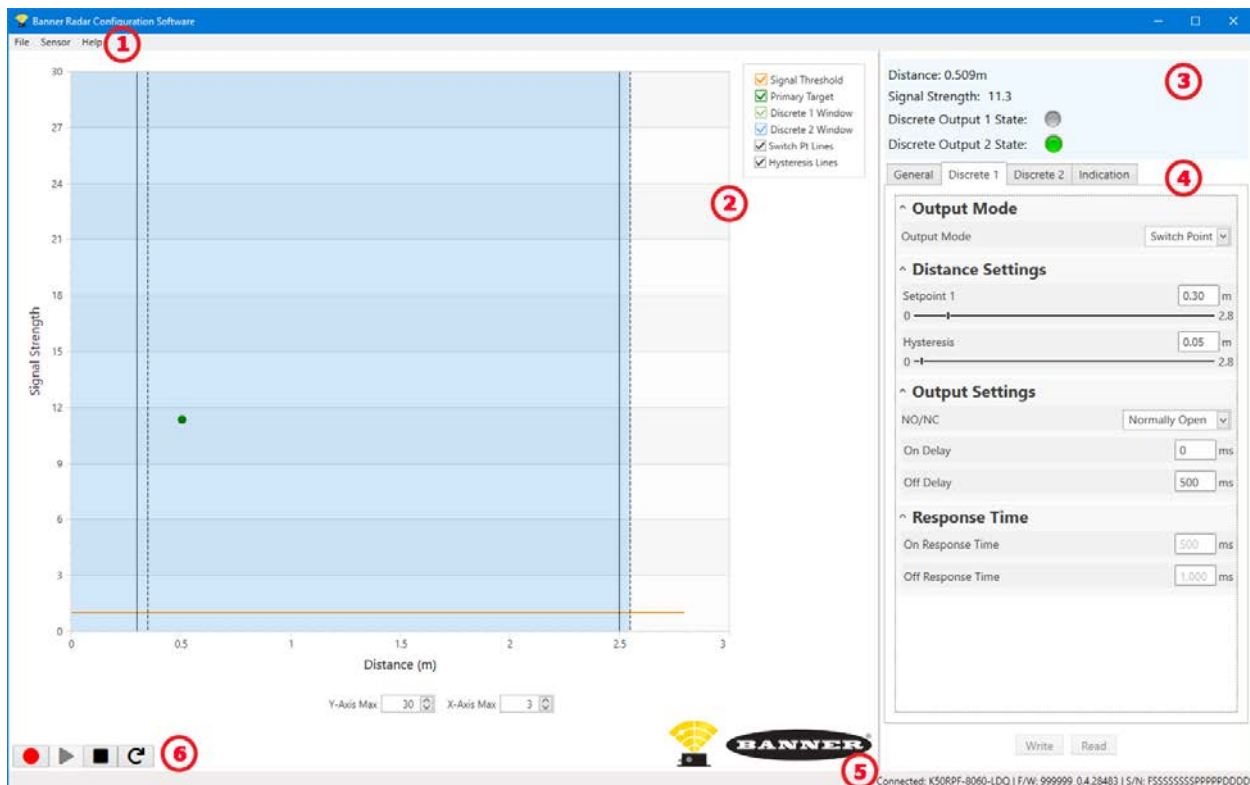

1. Navigation toolbar—Use this toolbar to connect to the sensor, to save or load a configuration, or to reset to factory defaults
2. Live Sensor Data and Legend—Shows the signal strength versus distance for the connected sensor, as well as options to select which data displays on the graph
3. Summary pane—Displays the distance to the target, the signal strength, and the output status
4. Sensor Settings pane—Set the sensor parameters in this pane
5. Status bar—Shows whether the sensor is connected, if a software update is available, and if the sensor data is being recorded to a file
6. Live Sensor Data controls—Use these controls to record, freeze, and play real-time sensor data, and to refresh the sensor connection

4 Banner Radar Configuration Workspace

4.1 Navigation Toolbar

Use this toolbar to connect to the sensor, to save or load a configuration, or to reset to factory defaults.

From the **File** menu, the following options are available:

Load Config

Load a configuration to the connected sensor. Use this option to set up multiple sensors with the same parameters.

Save Config

Save a configuration to a desired location for future use.

Reset Frequently Used Settings

Resets the software settings without changing the configuration of the attached sensor.

Exit

Exit the Banner Radar Configuration Software.

From the **Sensor** menu, the following options are available:

Connect

Connect to the sensor.

Disconnect

Disconnect from the sensor.

Factory Reset

Select to perform a factor reset on the sensor. All custom parameters will be lost.

From the **Help** menu, the following option is available:

About

Select to view the software version number, the copyright notice, and the warranty.

4.2 Live Sensor Data and Legend

The Live Sensor Data area displays the live distance and amplitude signal from the connected radar sensor. The signal strength threshold, switch point, and hysteresis are also plotted. Use these signals to evaluate targets to determine where the signal strength threshold and switch point should be configured for reliable detection.

Use the **Y-Axis Max** and the **X-Axis Max** to adjust the range displayed on the plot.

Legend

Use the legend to select which data appears on the graph.

Signal Threshold

Displays the signal strength threshold.

Primary Target

Represents the signal strength and location of the nearest target inside the switch point.

Discrete 1/2 Window ¹

The range for the discrete output.

Switch Point Lines

Displays the switch point distance.

Hysteresis Lines

Displays the hysteresis distance.

¹ Varies by output model.

4.3 Summary Pane

The **Summary** pane (blue shaded area) displays **Distance**, **Signal Strength**, and **Output Status**.

Distance

Displays the distance to the target.

Signal Strength

Displays the amount of excess gain of the signal received from the target. The excess gain is relative to the minimum detection threshold (Signal Strength Threshold = 1).

Output Status

Displays whether the output is ON or OFF.

4.4 Sensor Settings Pane

Set parameters for the sensor.

Click **Read** to read the connected sensor's current parameters. Click **Write** to write the parameters to the sensor. Yellow highlight on a parameter's value indicates changes that have not yet been written to the sensor.

4.4.1 General Tab

The following are the parameters on the **General** tab on the **Sensor Settings** pane.

Response Speed

Choose the response speed of the sensor (Slow, Medium, Fast).

Target Selection

Signal Strength Threshold: The threshold for the minimum amount of signal needed to actuate the output.

Target Mode:

Nearest Target—Output responds to the nearest target that is over the signal strength threshold.

Advanced Target

Minimum Active Sensing Range: Sensor ignores anything from the face of the sensor to this defined range.

Maximum Active Sensing Range: Sensor ignores anything past this defined range.

Measurement Hold: A rate of change filter to smooth the output and reduce chatter. For more information, see [Using Measurement Hold Example](#) on page 18.

Hold Time: The period of time the sensor holds its last measurement and output status if the measurement changes more than the **Maximum Distance Increase** or the **Maximum Distance Decrease**. Available when **Measurement Hold** is set to enabled.

Maximum Distance Increase: The allowed limit the measurement can increase, or move farther away from the sensor, before initiating the **Measurement Hold**. Setting this to zero disables it. Available when **Measurement Hold** is set to enabled.

Maximum Distance Decrease: The allowed limit the measurement can decrease, or move closer to the sensor, before initiating the **Measurement Hold**. Setting this to zero disables it. Available when **Measurement Hold** is set to enabled.

Sensor Polarity

Define the output and remote input signal type.

Sensor Lockout

Remote Input (Gray Wire): Enable or disable the remote input wire.

LED Enable/Disable

Enable or disable the LEDs on the sensor (Standard models only).

For Pro models, see [Indication Tab](#) on page 11 for LED configuration.

4.4.2 Discrete 1 Tab

The following are the parameters on the **Discrete 1** tab on the **Sensor Settings** pane.

Output Mode

Select **Switch Point** or **Window**.

Switch Point: The distance at which the switch point threshold is placed.

Window: Define two set points to create window limits.

Distance Settings

Define the set point(s) and the hysteresis.

Output Settings

NO/NC: Select **Normally Open** or **Normally Closed** from the list.

On Delay: Set an on delay in milliseconds. The maximum time is 60,000 ms.

Off Delay: Set an off delay in milliseconds. The maximum time is 60,000 ms.

Response Time

Calculates the total response time, taking into account the general response speed and on or off delays.

Table 1: Discrete

Response Speed	Discrete Output ON Spec (ms)	Discrete Output OFF Spec (ms)
Fast	200	700
Medium	500	1000
Slow	1500	2000

4.4.3 Discrete 2 Tab

The following are the parameters on the **Discrete 2** tab on the **Sensor Settings** pane. This tab is available for dual discrete models.

Output Mode

Select **Switch Point**, **Window**, **Complementary**, or **Pulse Pro/PFM**.

Switch Point: Set a single switch point for the output to change.

Window: Define two setpoints to create window limits.

Complementary: Output 2 is opposite of Output 1.

Pulse Pro/PFM: Pulse Pro/Pulse Frequency Modulation (PFM) output to interface with Banner lights or a PLC with PFM inputs.

Distance Settings

Available when Output Mode is set to **Switch Point** or **Window**.

Define the set point(s) and the hysteresis.

Output Settings

Available when Output Mode is set to **Switch Point** or **Window**.

NO/NC: Select **Normally Open** or **Normally Closed** from the list.

On Delay: Set an on delay in milliseconds. The maximum time is 60,000 ms.

Off Delay: Set an off delay in milliseconds. The maximum time is 60,000 ms.

Response Time

Calculates the total response time, taking into account the general response speed and on or off delays.

Table 2: Discrete

Response Speed	Discrete Output ON Spec (ms)	Discrete Output OFF Spec (ms)
Fast	200	700
Medium	500	1000
Slow	1500	2000

Pulse Pro/PFM Settings

Available when Output Mode is set to **Pulse Pro/PFM**.

The K50R can generate pulses whose frequency are proportional to the sensor's measured distance, thereby providing a method for representing an analog signal with only a discrete counter. The sensing range of the sensor is scaled from 100 Hz to 600 Hz. An output of 50 Hz or 650 Hz (user defined in the software) represents a loss of signal condition where there is no target or the target is out of range. This output can be tied directly to a number of Banner lights for visual feedback without the need for a controller.

100 Hz: Define one sensing range limit of the Pulse Pro range.

600 Hz: Define another sensing range limit of the Pulse Pro range.

Loss-of-Signal: Sets the value used by the sensor during a loss of signal. When a signal is restored, measurement resumes.

Hold last value—The Discrete 2 Output holds the last value indefinitely during a loss of signal.

50 Hz—The Discrete 2 Output switches to this value 2 seconds after a loss of signal.

650 Hz—The Discrete 2 Output switches to this value 2 seconds after a loss of signal.

4.4.4 Indication Tab

Use this tab to configure advanced indications for Pro models with configurable LEDs.

See [Configure a Pro Sensor](#) on page 19 for details.

4.5 Live Sensor Data Controls

After connecting to the sensor, data sampling begins automatically (but not recording).

To stop data sampling, click  **Stop**.

To restart data sampling, click  **Play**. This only samples data from the sensor and displays it on the plot; it does not record the data to a log file.

To record data to a log file, click  **Record**. The log file selection prompt displays. Save the log file as desired. The log file format is .csv.

If communication to the sensor is lost, click  **Refresh Device Connection** to reconnect.

5 Configuring a Sensor

5.1 Banner Radar Configuration Software

Use the Banner Radar Configuration software and Pro Converter Cable to set up the R-GAGE sensor.

For more information visit www.bannerengineering.com/us/en/products/sensors/software/radar-configuration.html.

5.2 Remote Input

Use the remote input to program the sensor remotely.

The remote input provides limited programming options and is Active High. For Active High, connect the gray input wire to V + (10 V DC to 30 V DC), with a remote switch connected between the wire and ground. This can be configured for Active Low in the Banner Radar Configuration software by changing the **Sensor Polarity**. For Active Low, connect the gray input wire to ground (0 V DC).

The remote input wire is disabled by default. Pulse the remote input wire 10 times or use the Banner Radar Configuration software to enable the feature. After enabling the remote input feature, pulse the remote input according to the diagram and the instructions provided in this manual. Remote teach can also be performed using the button on the Pro Converter Cable.

The length of the individual programming pulses is equal to the value T: **0.04 seconds ≤ T ≤ 0.8 seconds**.

Exit remote programming modes by setting the remote input Low for longer than 2 seconds or by waiting for 60 seconds.

Figure 8. Remote Input Map

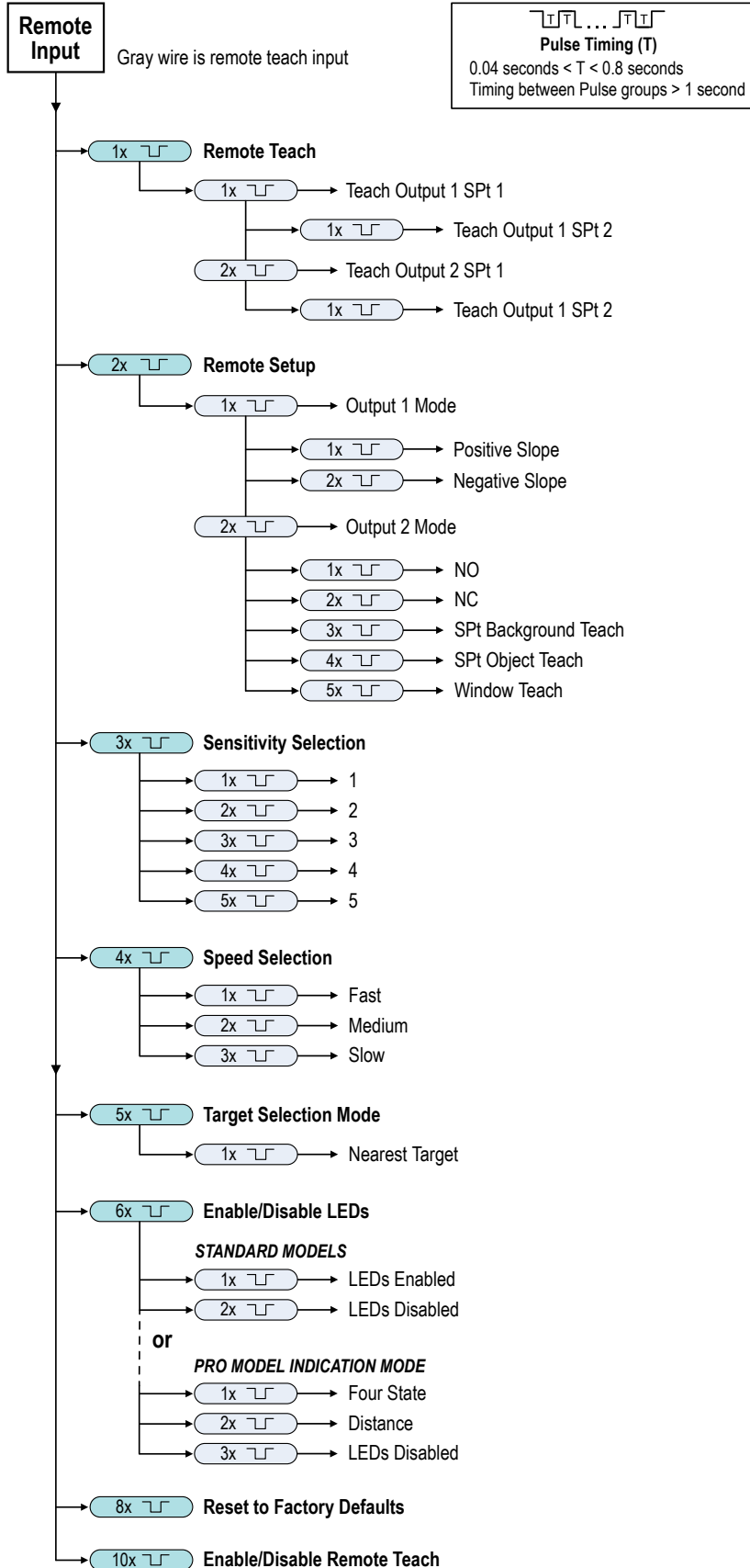



Note: If a factory reset is performed through the Banner Radar Configuration Software, the remote input wire becomes disabled (factory default setting). If the sensor is returned to factory defaults by using the remote input wire, the input wire remains enabled and the rest of the settings are restored to factory defaults.

5.2.1 Remote Teach

Use the following procedure to teach the first and second switch points.



Note: If Indication is disabled from the Banner Radar Configuration Software or a Pro model is being used, no LEDs are active during the following procedure.

1. Pulse the remote input once.
The Power/Signal LED flashes green rapidly and both amber LEDs are off.
2. Present the first point.
3. Teach the switch point.

Action	Result
Single-pulse the remote input. 	<p>Teach Accepted</p> <p>The amber LED of the output being taught flashes while the amber LED of the output not being taught is off. The Power/Signal LED indicates signal strength.</p> <p>Teach Not Accepted</p> <p>The Power/Signal LED continues to flash green and the amber output LED is off. Retry teaching the first point.</p>

4. Present the second point.
5. Teach the switch point.

Action	Result
Single-pulse the remote input. 	<p>Teach Accepted</p> <p>The Power/Signal LED turns on. The sensor returns to run mode.</p> <p>Teach Not Accepted</p> <p>The Power/Signal LED continues to indicate signal strength, the amber LED of the output being taught continues to flash while the amber LED of the output not being taught is off. Retry teaching the second point.</p>

5.2.2 Remote Setup

Use Remote Setup to set the output mode to normally open or normally closed, or to set the teach mode.

Changing the output to normally open or normally closed takes effect immediately and does not alter the switch point distance. Changing Teach mode does not immediately change the switch point location, but will affect the behavior of the next remote Teach.

Discrete Teach Modes

Teaching two separate points creates a window around that range.

Background Teach—Teaching the same point twice (points within 100 mm of each other) sets the switch point 200 mm in front of the taught point.

Object Teach—Teaching the same point twice (points within 100 mm of each other) sets the switch point 100 mm behind the taught point.

Window Teach—Teaching the same point twice (points within 100 mm of each other) sets a window ±50 mm on either side of the taught point, for a total window size of 100 mm.

Set the Sensitivity

Use Sensitivity Selection to set the signal strength threshold.



Note: If Indication is disabled from the Banner Radar Configuration Software or a Pro model is being used, no LEDs are active during the following procedure.

1. Access Sensitivity Selection.

Action		Result
Triple-pulse the remote input.		The Power/Signal LED flashes.

2. Select the desired signal threshold.

Action		Result
Pulses	TEACH Mode	The signal threshold is set and the Power/Signal LED flashes green equal to the number of pluses, pauses, and then flashes equal to the number of pulses a second time. Then the sensor exits remote teach and returns to run mode.
1	Signal Strength Threshold = 1	
2	Signal Strength Threshold = 2	
3	Signal Strength Threshold = 3	
4	Signal Strength Threshold = 4	
5	Signal Strength Threshold = 5	

Set the Speed

Use Speed Selection to set the speed of the sensor.



Note: If Indication is disabled from the Banner Radar Configuration Software or a Pro model is being used, no LEDs are active during the following procedure.

1. Access Speed Selection.

Action		Result
Four-pulse the remote input.		The Power/Signal LED flashes.

2. Select the desired signal threshold.

Action		Result
Pulses	TEACH Mode	The speed is set and the Power/Signal LED flashes green equal to the number of pluses, pauses, and then flashes equal to the number of pulses a second time. The sensor exits remote teach and returns to run mode.
1	Speed = Fast	
2	Speed = Medium	
3	Speed = Slow	

Target Selection Mode

Use Target Selection to set the target that the output sees.



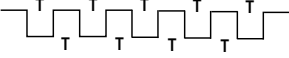

Note: If Indication is disabled from the Banner Radar Configuration Software or a Pro model is being used, no LEDs are active during the following procedure.

1. Access Target Selection mode.

Action	Result
Five-pulse the remote input. 	The Power/Signal LED flashes.

2. Select the desired signal threshold.

Action	Result				
<table border="1"> <thead> <tr> <th>Pulses</th> <th>TEACH Mode</th> </tr> </thead> <tbody> <tr> <td>1 </td> <td>Nearest Target—Output responds to the nearest target that is over the signal strength threshold.</td> </tr> </tbody> </table>	Pulses	TEACH Mode	1 	Nearest Target—Output responds to the nearest target that is over the signal strength threshold.	The signal threshold is set and the Power/Signal LED flashes green equal to the number of pluses, pauses, and then flashes equal to the number of pulses a second time. Then the sensor exits remote teach and returns to run mode
Pulses	TEACH Mode				
1 	Nearest Target—Output responds to the nearest target that is over the signal strength threshold.				



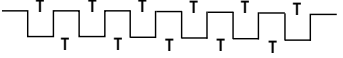

LED Enable/Disable

Use LED Enable/Disable to turn the LEDs on or off.

1. Access LED Enable/Disable mode.

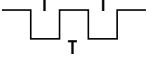
Action	Result
Six-pulse the remote input. 	The Power/Signal LED flashes.

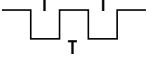
2. Select the desired signal threshold.

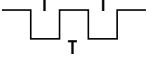
Action	Result						
<table border="1"> <thead> <tr> <th>Pulses</th> <th>TEACH Mode</th> </tr> </thead> <tbody> <tr> <td>1 </td> <td>LEDs enabled</td> </tr> <tr> <td>2 </td> <td>LEDs disabled</td> </tr> </tbody> </table>	Pulses	TEACH Mode	1 	LEDs enabled	2 	LEDs disabled	If disabled, the Power/Signal LED immediately turns off. If enabled, the Power/Signal LED flashes one time, pauses, and then flashes again. Then the sensor exits remote teach and returns to run mode.
Pulses	TEACH Mode						
1 	LEDs enabled						
2 	LEDs disabled						

5.3 Reset the Sensor to Factory Defaults

Reset the sensor to factory default settings using one of two methods.



Note: If a factory reset is performed through the Banner Radar Configuration Software, the remote input wire becomes disabled (factory default setting). If the sensor is returned to factory defaults by using the remote input wire, the input wire remains enabled and the rest of the settings are restored to factory defaults.

Reset Using the Banner Radar Configuration Software

Go to **Sensor > Factory Reset**. The sensor indicators flash once, the sensor is reset back to the factory default settings, and a confirmation message displays.

Reset Using the Remote Input

Eight-pulse the remote input to apply the factory defaults.



5.3.1 Factory Default Settings

Table 3: General Tab Default Settings

Setting	Factory Default
Response Speed	Medium
Signal Strength Threshold	1.0
Target Mode	Nearest Target
Measurement Hold	Disabled
Discrete Output & Remote Input	PNP
Remote Input Wire	Disabled
LED Indicators	Enabled

Table 4: Discrete 1 Tab Default Settings

Setting	Factory Default
Output Mode	Switch Point
Setpoint 1	2.5 m (8.2 ft)
Hysteresis	0.05 m (2 in)
NO/NC	Normally Open
On Delay	0 ms
Off Delay	500 ms

Table 5: Discrete 2 Tab Default Settings

Setting	Factory Default
Output Mode	Switch Point
Setpoint 1	2.5 m (8.2 ft)
Hysteresis	0.05 m (2 in)
NO/NC	Normally Open
On Delay	0 ms
Off Delay	500 ms

5.4 Using Measurement Hold Example

Figure 9. Measurement Hold

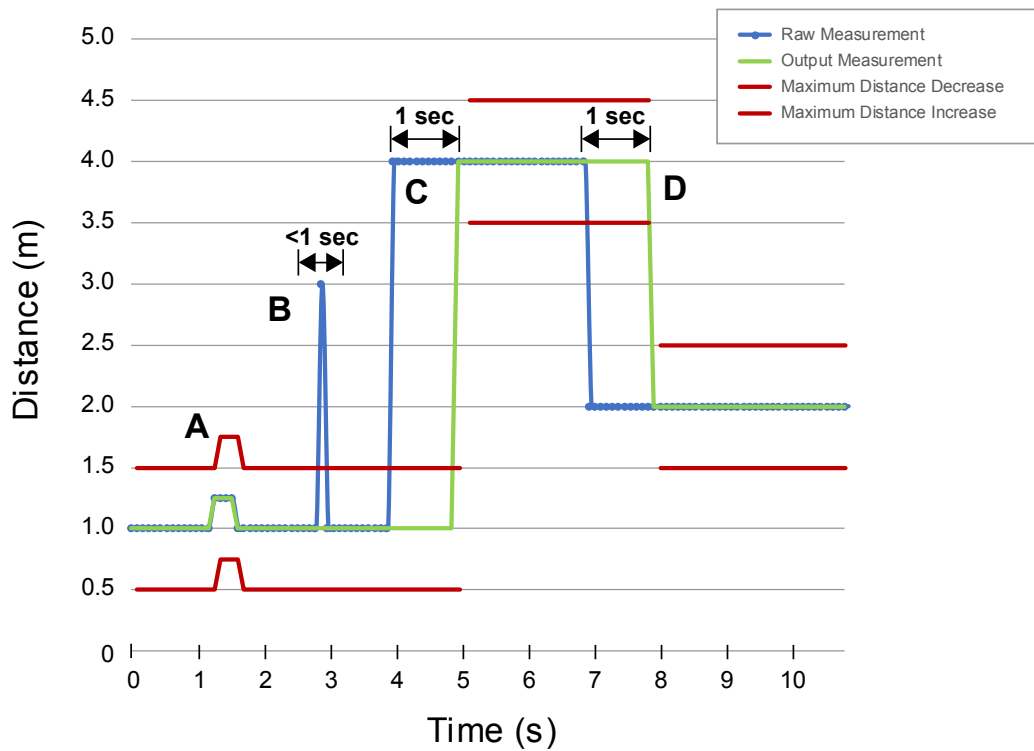

The Hold Time is set to 1 second.

- A. The Max Distance Change threshold (red lines) adapts based on the previous Raw Measurement sample (blue lines) as long as that sample was within the previous thresholds.
- B. The temporary distance spike in the Raw Measurement (blue lines) is filtered out because the distance increase was outside of the Max Distance Change (red lines). The Output Measurement (green lines) will hold its last measurement.
- C. The Raw Measurement change (blue lines) is greater than the Max Distance Change (red lines) so the Output Measurement (green lines) holds its previous value while the Raw Measurement is beyond the Max Distance Change. After the 1 second Hold Time expires, the Output Measurement and Max Distance Change thresholds are updated based on the next Raw Measurement value.
- D. The Raw Measurement (blue lines) drops down to a value below the Max Distance Change (red lines) so the Output Measurement (green lines) holds its value for the Hold Time. After the 1 second Hold Time expires, the Output Measurement and Max Distance Change thresholds are updated based on the next Raw Measurement value.

6 Configure a Pro Sensor

The Pro sensor models offer advanced indication of distance thresholds and device states.

Use the options on the **Indication** tab to configure the desired LED options.

Color 1 and Color 2

The following colors are available for Color 1 and Color 2.²

- Green
- Red
- Orange
- Amber
- Yellow
- Lime Green
- Spring Green
- Cyan
- Sky Blue
- Blue
- Violet
- Magenta
- Rose
- White

Intensity 1 or Intensity 2

The Intensity control sets the intensity of a color.

Intensity	Description
High	100%
Medium	60%
Low	25%
Off	0%

Animation

The type of animation, if any, that is used when the threshold is reached.

Animation	Description
Off	All LEDs are off
Steady	Color 1 is solid ON at the defined intensity
Flash	Color 1 flashes at the defined speed, color intensity, and pattern (normal, strobe, three pulse, SOS, or random)
Two Flash	Color 1 and Color 2 flash alternately at the defined speed, color intensities, and pattern (normal, strobe, three pulse, SOS, or random)
50/50	Color 1 displays ON 50% and Color 2 displays ON the other 50% statically at the defined color intensities
50/50 Rotate	Color 1 displays ON 50% and Color 2 displays ON the other 50% statically at the defined color intensities
Chase	Color 1 displays as a single spot against the background of Color 2 while rotating at the defined speed, color intensities, rotational direction
Intensity Sweep	Color 1 repeatedly increases and decreases intensity between 0% and the defined intensity at the defined speed

² The following colors are uncalibrated to achieve higher saturation: Red, Green, and Blue. They may show greater variance between devices than other colors.

Pattern

The Pattern control sets the pattern of the flash animation.

Pattern	Description
Normal	Alternating Color 1; Color 2 at 50% duty cycle
Strobe	Continuous Color 1; Color 2 flashes at 20% duty cycle
3-Pulse	Three consecutive Color 1 pulses at 10% duty cycle on Color 2 background
SOS	Short pulse, short pulse, short pulse, long pulse, long pulse, long pulse, short pulse, short pulse, short pulse alternating Color 1 and Color 2
Random	Random sequence of light signals

Speed

The Speed control sets the speed of some animation options.

Flash Animation Speed

Speed	Description
Slow	0.5 Hz
Standard	1 Hz
Fast	5 Hz

Rotational and Chase Animation Speed

Speed	Description
Slow	1 Hz
Standard	2 Hz
Fast	4Hz

6.1 Distance Mode

Distance mode utilizes the sensor's colored LEDs to proportionally display an object's distance from the face of the sensor.

Application examples:

- Vehicle position feedback
- Object distance tracking
- Monitoring fill level
- Indicating when an object is within a specific warning zone

To select Distance mode, select **Distance** from the **Device Logic** menu on the **Indication** tab.

Use the options to set the sensor animation and color(s) for when an object is within the sensing window, out of the sensing window, and when no object is found.

Figure 10. Distance States

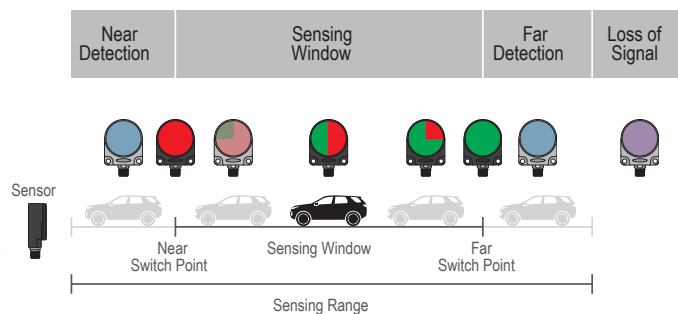

First, define the **Distance Settings**. The **Distance Setting** is the user-defined distance that the LEDs will proportionally change from. **Switch Point 1** and **Switch Point 2** must be within the sensing range.

Next, define the **Near Detection**, **Sensing Window**, **Far Detection**, and **Loss of Signal** states. Multiple distance states are available to change color, flashing, and intensity as the input distance value changes based on the defined **Distance Settings**. For more information on each state, click **Distance States** under **Device Logic**.

Distance Settings—Match Distance Settings

Discrete 1—The distance matches the distance settings of Discrete 1. If Discrete 1 is in Output Mode **Switch Point**, the sensing window is 0.1 m to Switch Point 1. If Output Mode is **Window**, the sensing window is between Switch Point 1 and Switch Point 2.

Discrete 2—The distance matches the distance settings of Discrete 2. If Discrete 2 is in Output Mode **Switch Point**, the sensing window is 0.1 m to Switch Point 2. If Output Mode is **Window**, the sensing window is between Switch Point 1 and Switch Point 2. If Output Mode is **Complementary**, the sensing window matches Discrete 1.

Custom—The sensing window is defined by setting the Near Switch Point and Far Switch point. It is independent of both Discrete 1 and Discrete 2.

Near Detection

The LED behavior when the object is between the minimum sensing range and Switch Point 1.

Sensing Window

The LED behavior when the object distance is within Switch Point 1 and Switch Point 2. A steady global background color and intensity can be applied.

Far Detection

The LED behavior when the object is between the maximum sensing range and Switch Point 2.

Loss of Signal

The LED behavior when no object is present, or outside of the sensing range.

6.2 Four State Mode

When using Four State Full Logic, the sensor can be programmed to display LED indication states for up to four sensor states or zones. The states depend on the discrete output windows set in the **Discrete 1** and **Discrete 2** tabs.

Example applications:

- Visual indication for warning zones
- Availability of parking space
- Product placement or position

Figure 11. Four State Full Logic Table

Four State Full Logic	Discrete 1 OFF	Discrete 1 ON
Discrete 2 OFF	State 1	State 3
Discrete 2 ON	State 2	State 4

To select Four State mode, select **Four State** from the **Device Logic** menu on the **Indication** tab.

Use the options to set the sensor animation and color(s) for each logic state.

6.3 Enable/Disable the LEDs

If the LEDs become distracting or to conserve power, they can be disabled.

Use the following procedure to enable or disable the LEDs.

1. On the **Indication** tab, on the **Device Logic** menu, select **LEDs Disabled**.
The option turns yellow.
2. Click **Write** to write the parameter to the sensor.
The LEDs are disabled.
3. To enabled the LEDs, select either **Distance** or **Four State** from the **Device Logic** menu.
4. Click **Write** to write the parameter to the sensor.
The LEDs are enabled and the sensor can be configured for Distance or Four State.

7 Specifications

Range

The sensor can detect an object at the following ranges, depending on the material of the target: 100 mm to 2.5 m

Operating Principle

Pulsed coherent radar (PCR)

Operating Frequency

60.5 GHz

Supply Voltage (Vcc)

10 V DC to 30 V DC

Use only with a suitable Class 2 power supply (UL) or Limited Power Supply (CE)

Power and Current Consumption, exclusive of load

Standard models:

Power consumption: <1.0 W at 24 V

Current consumption: <35 mA at 24 V

Pro models:

Power consumption: <1.5 W at 24 V

Current consumption: <55 mA at 24 V

Supply Protection Circuitry

Protected against reverse polarity and transient overvoltages

Linearity

< ± 2 mm from 100 mm to 250 mm

< ± 4 mm from 250 mm to 800 mm

< ± 8 mm from 800 mm to 2.5 m

Reference target with RCS = 1m²

Delay at Power-up

< 1 s

Output Configuration

Discrete Output 1 (Black Wire): Configurable PNP or NPN output

Discrete Output 2 (White Wire): Configurable PNP or NPN output or Pulse Frequency Modulated (PFM) output

Output Ratings

Current rating = 50 mA maximum each

Black wire specifications per configuration		
PNP	Output High	≥ Vsupply - 2.5 V
	Output Low	≤ 1V (loads ≤ 1 MegΩ)
NPN	Output High	≥ Vsupply - 2.5 V
	Output Low	≤ 2.5 V

White wire specifications per configuration		
PNP	Output High	≥ Vsupply - 2.5 V
	Output Low	≤ 2.5 V (loads ≤ 70 kΩ)
NPN	Output High	≥ Vsupply - 2.5 V
	Output Low	≤ 2.5 V

Repeatability ³

4 mm from 100 to 250 mm

8 mm from 250 mm to 800 mm

16 mm from 800 mm to 2.5 m

Maximum Output Power

EIRP: 10dBm

Output Protection

Protected against output short-circuit

Remote Input

Allowable Input Voltage Range: 0 to Vsupply

Active High (internal weak pull-down): High state > (Vsupply - 2.25 V) at 2 mA maximum

Active Low (internal weak pull-up): Low state < 2.25 V at 2 mA maximum

Response Time

Discrete output response: 200 ms

Speeds given for fast mode.

Indicators

Standard models:

Power LED/Signal Strength: Green or blue depending on sensor state

Output LEDs: Amber, target within taught discrete output status

Pro models: User configurable

Construction

Housing: Polycarbonate

Window: Polycarbonate

Connections

Integral M12 quick disconnect

Models with a quick disconnect require a mating cordset



Note: A shielded cable is required if the sensor is mounted outdoors or if the cable is longer than 30 m (98.4 ft).

Vibration and Mechanical Shock

All models meet MIL-STD-202F, Method 201A (Vibration: 10 Hz to 60 Hz maximum, 0.06 inch (1.52 mm) double amplitude, 10G acceleration) requirements. Method 213B conditions H&I. Shock: 75G with device operating; 100G for non-operation

Operating Temperature

Standard model: -40 °C to +60 °C (-40 °F to +140 °F)

Temperature Effect

<±5 mm from -40 °C to +60 °C (-40 °F to +140 °F)

Environmental Rating

IP67

Certifications



Banner Engineering Europe
Park Lane, Culliganlaan 2F bus 3,
1831 Diegem, BELGIUM

Turck Banner LTD Blenheim
House, Blenheim Court, Wickford,
Essex SS11 8YT, Great Britain

Contains FCC ID: 2AQ6KA1001

Contains IC: 24388-A111

for others, contact Banner Engineering

Advanced Capabilities



Country of Origin

USA

³ At medium response speed.

7.1 FCC Part 15 Class A

This equipment has been tested and found to comply with the limits for a Class A digital device, pursuant to part 15 of the FCC Rules. These limits are designed to provide reasonable protection against harmful interference when the equipment is operated in a commercial environment. This equipment generates, uses, and can radiate radio frequency energy and, if not installed and used in accordance with the instruction manual, may cause harmful interference to radio communications. Operation of this equipment in a residential area is likely to cause harmful interference in which case the user will be required to correct the interference at his own expense.

7.2 Industry Canada

Contains IC: 24388-A111—This device contains licence-exempt transmitter(s)/receiver(s) that comply with Innovation, Science and Economic Development Canada's licence-exempt RSS(s). Operation is subject to the following two conditions:

1. This device may not cause interference.
2. This device must accept any interference, including interference that may cause undesired operation of the device.

Cet appareil contient des émetteurs/récepteurs exemptés de licence conformes à la norme Innovation, Sciences, et Développement économique Canada. L'exploitation est autorisée aux deux conditions suivantes:

1. L'appareil ne doit pas produire de brouillage.
2. L'utilisateur de l'appareil doit accepter tout brouillage radioélectrique subi, même si le brouillage est susceptible d'en compromettre le fonctionnement.

7.3 PC Requirements

Operating System
Microsoft® Windows® operating system version 10 ⁴

Hard Drive Space
500 MB

Third-Party Software
.NET

USB Port
Available USB port



Important: Administrative rights are required to install the Banner Radar Configuration software.

7.4 Dimensions

All measurements are listed in millimeters [inches], unless noted otherwise.

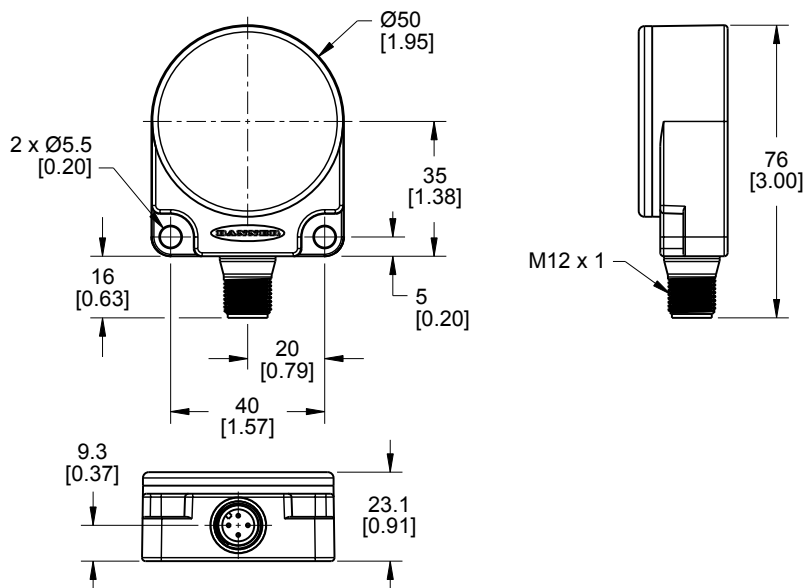

⁴ Microsoft and Windows are registered trademarks of Microsoft Corporation in the United States and/or other countries.

7.5 Beam Patterns

The beam pattern of the radar sensor is dependent on the radar cross section (RCS) of the target.

The beam pattern graphs are guides for representative object detection capabilities based on different sized radar cross sections and corresponding example real world targets. Use the following charts as a starting point in application setup. Note that applications vary.

- Use the Beam Width versus Distance chart to understand where corresponding objects can be detected. Adjusting the signal strength threshold also affects the beam pattern when the target is constant.
- Use the Beam Width versus Degrees chart to help determine how much the target can tilt from 90 degrees while still maintaining detection.

Unless otherwise specified, the following beam patterns are shown with Signal Strength Threshold = 1.

Figure 12. Typical beam pattern, in millimeters, on representative targets

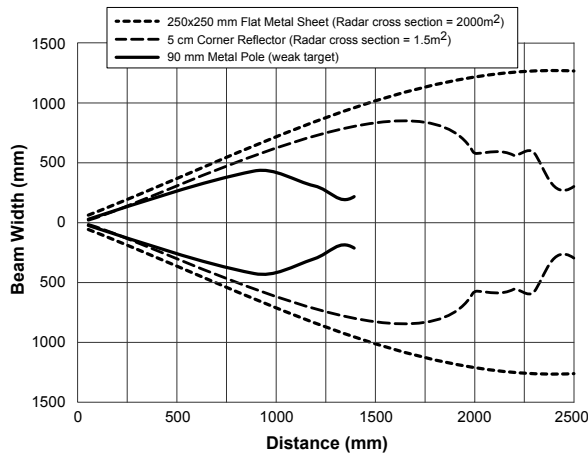

Figure 13. Typical beam pattern, in degrees, on representative targets

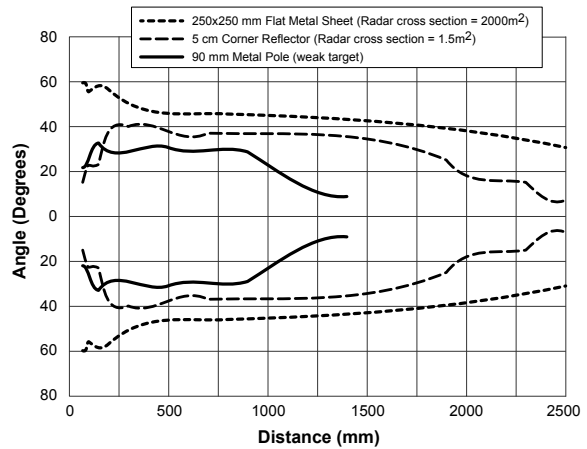

Figure 14. Typical beam pattern, in millimeters, with 250 × 250 mm Flat Metal Sheet (Radar cross section = 2000m²) and various signal strength thresholds

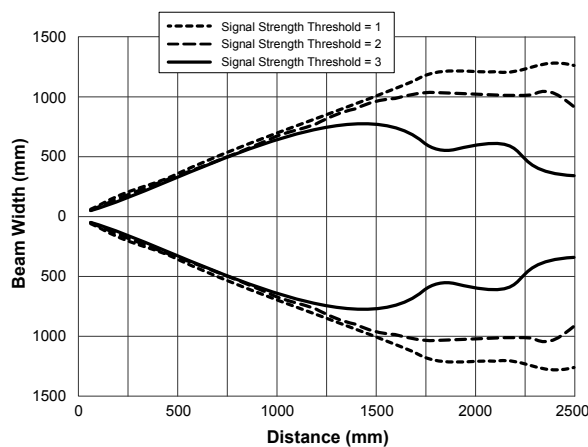
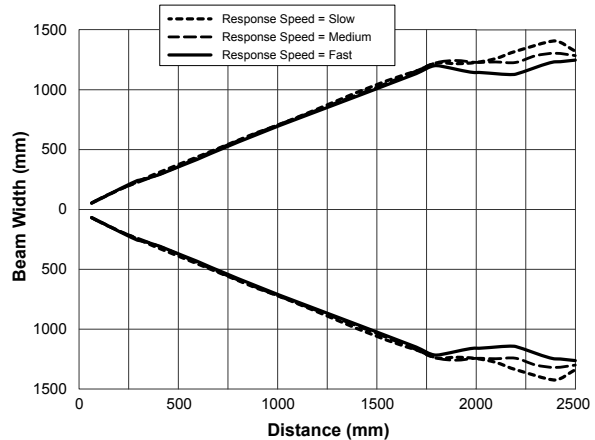

Figure 15. Typical beam pattern, in millimeters, with 250 × 250 mm Flat Metal Sheet (Radar cross section = 2000m²) and various response speeds



8 Update the Software

Use this procedure to update the Banner Radar Configuration Software.

The Banner Radar Configuration Software automatically looks for updated software versions. The symbol  in the lower right corner indicates that a software update is available.

Figure 16. Software Update Available



1. Click  in the lower right corner of the software.
The Banner Radar Configuration Software Update screen displays.

Figure 17. Banner Radar Configuration Software Update Screen

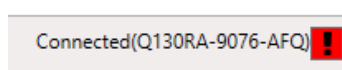

2. Click **Upgrade** to begin the process.
The Banner Radar Configuration Software closes and an installer (BannerRadarConfigInstaller.exe) downloads to the desktop.

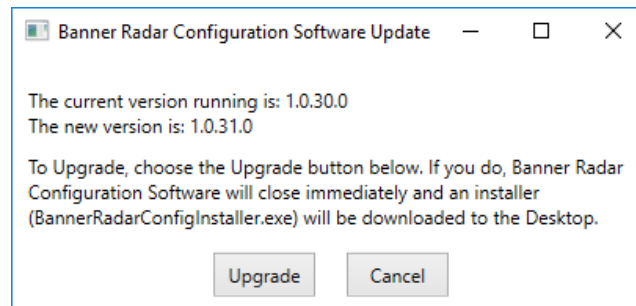

Note: If changes have not been written to the sensor, the system asks whether you want to exit the program. Click **No** to stop the update process and return to the Software. Write the changes to the sensor, then return to step 1, above, to update the Software.

3. Navigate to and open the file BannerRadarConfigInstaller.exe.
4. Depending on your system settings, a popup window may appear prompting to allow Banner Radar Configuration Software to make changes to your computer. Click **Yes**.
5. Click **Close** to exit the installer.

The software update is complete.

9 Accessories

9.1 Cordsets

5-Pin Threaded M12 Cordsets with Shield—Single Ended				
Model	Length	Style	Dimensions	Pinout (Female)
MQDEC2-506	2 m (6.56 ft)	Straight		<p>1 = Brown 2 = White 3 = Blue 4 = Black 5 = Gray</p>
MQDEC2-515	5 m (16.4 ft)			
MQDEC2-530	9 m (29.5 ft)			
MQDEC2-550	15 m (49.2 ft)			
MQDEC2-506RA	2 m (6.56 ft)	Right-Angle		
MQDEC2-515RA	5 m (16.4 ft)			
MQDEC2-530RA	9 m (29.5 ft)			
MQDEC2-550RA	15 m (49.2 ft)			



Note: A shielded cable is required if the sensor is mounted outdoors or if the cable is longer than 30 m (98.4 ft).

9.2 Configuration Tools

MQDC-506-USB

- Pro Converter Cable
- 1.83 m (6 ft) length 5-pin M12 quick disconnect to Device and USB to PC
- Required for connection to Pro Editor

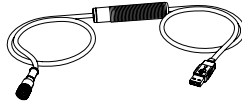

PRO-KIT

Includes:

- Pro Converter Cable (MQDC-506-USB)
- Splitter (CSB-M1251FM1251M)
- Power Supply (PSW-24-1)

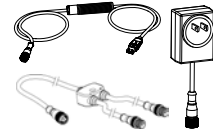

10 Product Support and Maintenance

10.1 Repairs

Contact Banner Engineering for troubleshooting of this device. **Do not attempt any repairs to this Banner device; it contains no field-replaceable parts or components.** If the device, device part, or device component is determined to be defective by a Banner Applications Engineer, they will advise you of Banner's RMA (Return Merchandise Authorization) procedure.



Important: If instructed to return the device, pack it with care. Damage that occurs in return shipping is not covered by warranty.

You may be asked to provide the configuration file and the data log file (.cfg) to aid in troubleshooting.

10.2 Contact Us

Banner Engineering Corp. headquarters is located at:

9714 Tenth Avenue North
Minneapolis, MN 55441, USA
Phone: + 1 888 373 6767

For worldwide locations and local representatives, visit www.bannerengineering.com.

10.3 Banner Engineering Corp. Software Copyright Notice

This software is protected by copyright, trade secret, and other intellectual property laws. You are only granted the right to use the software and only for the purposes described by Banner. Banner reserves all other rights in this software. For so long as you have obtained an authorized copy of this software directly from Banner, Banner grants you a limited, nonexclusive, nontransferable right and license to use this software.

You agree not to use, nor permit any third party to use, this software or content in a manner that violates any applicable law, regulation or terms of use under this Agreement. You agree that you will not reproduce, modify, copy, deconstruct, sell, trade or resell this software or make it available to any file-sharing or application hosting service.

Disclaimer of Warranties. Your use of this software is entirely at your own risk, except as described in this agreement. This software is provided "AS-IS." To the maximum extent permitted by applicable law, Banner, its affiliates, and its channel partners disclaim all warranties, expressed or implied, including any warranty that the software is fit for a particular purpose, title, merchantability, data loss, non-interference with or non-infringement of any intellectual property rights, or the accuracy, reliability, quality or content in or linked to the services. Banner and its affiliates and channel partners do not warrant that the services are secure, free from bugs, viruses, interruption, errors, theft or destruction. If the exclusions for implied warranties do not apply to you, any implied warranties are limited to 60 days from the date of first use of this software.

Limitation of Liability and Indemnity. Banner, its affiliates and channel partners are not liable for indirect, special, incidental, punitive or consequential damages, damages relating to corruption, security, loss or theft of data, viruses, spyware, loss of business, revenue, profits, or investment, or use of software or hardware that does not meet Banner minimum systems requirements. The above limitations apply even if Banner and its affiliates and channel partners have been advised of the possibility of such damages. This Agreement sets forth the entire liability of Banner, its affiliates and your exclusive remedy with respect to the software use. You agree to indemnify and hold Banner and its affiliates and channel partners harmless from any and all claims, liability and expenses, including reasonable attorney's fees and costs, arising out of your use of the Services or breach of this Agreement (collectively referred to as "Claims"). Banner reserves the right at its sole discretion and at its own expense, to assume the exclusive defense and control of any Claims. You agree to reasonably cooperate as requested by Banner in defense of any Claims.

10.4 Banner Engineering Corp. Limited Warranty

Banner Engineering Corp. warrants its products to be free from defects in material and workmanship for one year following the date of shipment. Banner Engineering Corp. will repair or replace, free of charge, any product of its manufacture which, at the time it is returned to the factory, is found to have been defective during the warranty period. This warranty does not cover damage or liability for misuse, abuse, or the improper application or installation of the Banner product.

THIS LIMITED WARRANTY IS EXCLUSIVE AND IN LIEU OF ALL OTHER WARRANTIES WHETHER EXPRESS OR IMPLIED (INCLUDING, WITHOUT LIMITATION, ANY WARRANTY OF MERCHANTABILITY OR FITNESS FOR A PARTICULAR PURPOSE), AND WHETHER ARISING UNDER COURSE OF PERFORMANCE, COURSE OF DEALING OR TRADE USAGE.

This Warranty is exclusive and limited to repair or, at the discretion of Banner Engineering Corp., replacement. **IN NO EVENT SHALL BANNER ENGINEERING CORP. BE LIABLE TO BUYER OR ANY OTHER PERSON OR ENTITY FOR ANY EXTRA COSTS, EXPENSES, LOSSES, LOSS OF PROFITS, OR ANY INCIDENTAL, CONSEQUENTIAL OR SPECIAL DAMAGES RESULTING FROM ANY PRODUCT DEFECT OR FROM THE USE OR INABILITY TO USE THE PRODUCT, WHETHER ARISING IN CONTRACT OR WARRANTY, STATUTE, TORT, STRICT LIABILITY, NEGLIGENCE, OR OTHERWISE.**

Banner Engineering Corp. reserves the right to change, modify or improve the design of the product without assuming any obligations or liabilities relating to any product previously manufactured by Banner Engineering Corp. Any misuse, abuse, or improper application or installation of this product or use of the product for personal protection applications when the product is identified as not intended for such purposes will void the product warranty. Any modifications to this product without prior express approval by Banner Engineering Corp will void the product warranties. All specifications published in this document are subject to change; Banner reserves the right to modify product specifications or update documentation at any time. Specifications and product information in English supersede that which is provided in any other language. For the most recent version of any documentation, refer to: www.bannerengineering.com.

For patent information, see www.bannerengineering.com/patents.

Index

A

advanced target 9

C

complementary 10

D

delay

off 10

on 10

discrete 1 tab 10

discrete 2 tab 10

discrete window 8

distance 9, 10

distance mode 20

F

four state mode 21

H

hold time 9

hysteresis 8, 10

I

indication tab 11

L

lockout 9

M

maximum active sensing range 9

maximum distance decrease 9

maximum distance increase 9

measurement hold 9

minimum active sensing range 9

mode

distance 20

four state 21

target selection 16

N

NC 10

NO 10

normally closed 10

normally open 10

O

off delay 10

on delay 10

output 10

output status 9

P

PC requirements 23

PFM 10

polarity 9

primary targets 8

Pulse Pro 10

R

response speed 9

response time 10

S

select target 16

sensor lockout 9

sensor polarity 9

Sensor Settings 9–11

signal 8

signal strength 9

signal threshold 8

software 8–12, 25

summary 9

switch point 10

switch point lines 8

T

tab

discrete 1 10

discrete 2 10

indication 11

target selection 9, 16

W

window 10

X

X axis 8

Y

Y axis 8