

PD45 Series PicoDot Polarized Retroreflective and Convergent Laser Sensors



Datasheet



- Compact and lightweight; ideal for use on robotic end effectors
- Class 2 laser light source
- Convergent beam models have precise, high-energy sensing spot at focus, available in four focal lengths: 50 mm (2 in), 100 mm (4 in), 200 mm (8 in), and 300 mm (12 in)
- Retroreflective models have precise, narrow beam; excellent for sensing the presence of tiny parts at close range, small parts at medium ranges, and for accurate sensing over long distances
- Fast, 0.2 millisecond sensing response for high-speed sensing or counting
- 10 to 30 V dc operation; choice of NPN or PNP complementary solid state output
- Choose models with 2 m (6.5 ft) or 9 m (30 ft) unterminated cable, or with 150 mm (6 in) Euro-style pigtail quick-disconnect (QD) connector

Retroreflective-Mode Models. Excellent for applications where high sensing power and small beam size are important. Operates over sensing ranges typically accomplished only by conventional opposed-mode photoelectrics; uses a special filter to polarize the emitted light, filtering out unwanted reflections from shiny objects. (Visible Red; Class 2 laser; 650 nm)

Retroreflective-Mode Models				
Models	Range	Cable	Output Type	Excess Gain ¹
PD45VN6LLP	0.2 m to 10.6 m (8 in to 35 ft) ²	2 m (6.5 ft) cable	NPN	
PD45VN6LLPQ		5-pin QD 150 mm (6 inch) pigtail		
PD45VP6LLP		2 m (6.5 ft) cable	PNP	
PD45VP6LLPQ		5-pin QD 150 mm (6 inch) pigtail		

To order 9 m (30 ft) cables, add the suffix “W/30” to the model number of any cabled sensor (e.g., PD45VN6LLP W/30). Models with QD connectors require an optional mating cable.

Convergent-Mode Models. Excels at sensing small parts and profiles and uses fixed-field technology to ignore objects beyond the maximum sensing distance. (Visible Red; Class 2 laser; 650 nm)

¹ Performance curves based on BRT-51X51BM retro target

² Range tested using a BRT-51X51BM retro target (included with each sensor). Actual range depends on the efficiency and size of the retroreflective target used. Some targets have produced ranges up to 39.6 m (130 ft).



Convergent-Mode Models - 50 mm (2 inch) Focus (Performance curves based on 90% white test card)				
Models	Cable	Output Type	Excess Gain	Beam Width
PD45VN6C50	2 m (6.5 ft) cable	NPN		
PD45VN6C50Q	5-pin QD 150 mm (6 inch) pigtail			
PD45VP6C50	2 m (6.5 ft) cable	PNP		
PD45VP6C50Q	5-pin QD 150 mm (6 inch) pigtail			

Convergent-Mode Models - 102 mm (4 inch) Focus (Performance curves based on 90% white test card)				
Models	Cable	Output Type	Excess Gain	Beam Width
PD45VN6C100	2 m (6.5 ft) cable	NPN		
PD45VN6C100Q	5-pin QD 150 mm (6 inch) pigtail			
PD45VP6C100	2 m (6.5 ft) cable	PNP		
PD45VP6C100Q	5-pin QD 150 mm (6 inch) pigtail			

Convergent-Mode Models - 203 mm (8 inch) Focus (Performance curves based on 90% white test card)				
Models	Cable	Output Type	Excess Gain	Beam Width
PD45VN6C200	2 m (6.5 ft) cable	NPN		
PD45VN6C200Q	5-pin QD 150 mm (6 inch) pigtail			
PD45VP6C200	2 m (6.5 ft) cable	PNP		
PD45VP6C200Q	5-pin QD 150 mm (6 inch) pigtail			

Convergent-Mode Models - 305 mm (8 inch) Focus (Performance curves based on 90% white test card)				
Models	Cable	Output Type	Excess Gain	Beam Width
PD45VN6C300	2 m (6.5 ft) cable	NPN		
PD45VN6C300Q	5-pin QD 150 mm (6 inch) pigtail			
PD45VP6C300	2 m (6.5 ft) cable	PNP		
PD45VP6C300Q	5-pin QD 150 mm (6 inch) pigtail			



WARNING: Not To Be Used for Personnel Protection

Never use this device as a sensing device for personnel protection. Doing so could lead to serious injury or death. This device does not include the self-checking redundant circuitry necessary to allow its use in personnel safety applications. A sensor failure or malfunction can cause either an energized or de-energized sensor output condition.

Retroreflective Sensor Alignment

Because the PicoDot laser sensor has such a long sensing range, and because its beam is so narrow (compared to the beam of typical retro sensors), its alignment is somewhat less forgiving and more difficult to accomplish. As indicated, the effect of angular misalignment can be dramatic, especially over distance. For example, with one 51 mm (2 in) reflective target mounted at a distance of 6 m (20 ft) from the sensor, only one degree of angular misalignment will cause the center of the laser beam to miss the center of the target by 102 mm (4 in), and miss the target altogether by almost 76 mm (3 in).

Alignment tip: When using a small retroreflective target at medium or long range, it is often useful to temporarily attach (or suspend) a strip of retroreflective tape (such as BRT-THG-2-100) along a line that intersects the real target. The visible red laser beam is easily seen in normal room lighting; sight along the beam toward the target, from behind the sensor. Move the sensor to scan the laser beam back and forth across the tape strip, to guide the beam onto the target.

The use of mounting bracket SMB-46A may simplify alignment, because of its precision-positioning feature. After mounting the bracket and the sensor, tighten the screws in the two corners of the bracket to position the beam in the exact spot needed.

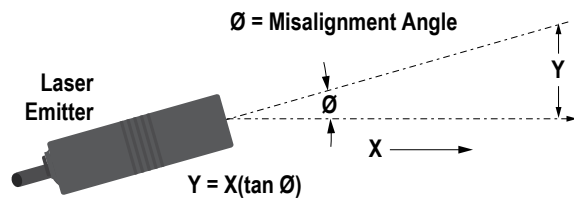

Figure 1. Beam displacement per degree of misalignment

Distance (X) To Retro Target	Beam Displacement (Y) for 1° of Misalignment
1.5 m (5 ft)	25 mm (1 in)
3 m (10 ft)	50 mm (2 in)
6 m (20 ft)	100 mm (4 in)
15 m (50 ft)	250 mm (10 in)
30 m (100 ft)	500 mm (20 in)

Retroreflective Sensor Beam Size

Unlike conventional retroreflective sensors, the retroreflective laser has the ability to sense relatively small profiles. The figures demonstrate the diameter of the smallest opaque rod that reliably breaks the laser beam at several sensor-to-object distances. These values assume an excess gain of about 10x. Flooding effects are possible when the gain is much higher (reduce sensor gain in this situation in order to reliably detect minimum object sizes).

Note the shape of the beam is elliptical and its size increases as the distance from the sensor increases. Minimum object detection sizes are dependent on both the object's distance from the sensor, and the direction (with respect to the beam's X and Y axes) in which the object crosses the beam.

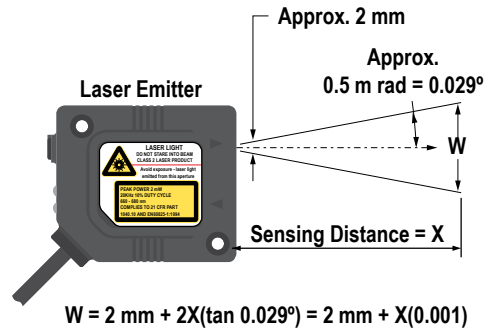

Figure 2. Beam divergence at 25°C (beam size vs. distance)

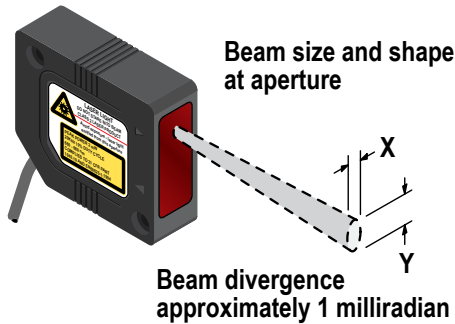

Figure 3. Minimum object detection size vs. distance

Distance from Sensor to Object	Minimum Detection size	
	X	Y
0.3 m (1 ft)	1.78 mm (0.07 in)	3.30 mm (0.13 in)
1.5 m (5 ft)	2.03 mm (0.08 in)	4.06 mm (0.16 in)
3 m (10 ft)	3.05 mm (0.12 in)	5.08 mm (0.20 in)
9 m (30 ft)	5.08 mm (0.20 in)	8.13 mm (0.32 in)
15 m (50 ft)	9.65 mm (0.38 in)	12.7 mm (0.50 in)
18 m (60 ft)	12.7 mm (0.50 in)	19.05 mm (0.75 in)

Installation Notes - Class 2 Laser Safety Notes

Low-power lasers are, by definition, incapable of causing eye injury within the duration of a blink (aversion response) of 0.25 seconds. They also must emit only visible wavelengths (400 to 700 nm). Therefore, an ocular hazard may exist only if individuals overcome their natural aversion to bright light and stare directly into the laser beam.

- Do not stare at the laser.
- Do not point the laser at a person's eye.
- Mount open laser beam paths either above or below eye level, where practical.
- Terminate the beam emitted by the laser product at the end of its useful path.

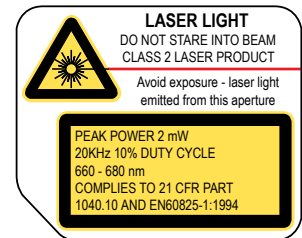

CAUTION: Use of controls adjustments or performance of procedures other than those specified herein may result in hazardous radiation exposure; per EN 60825. Do not attempt to disassemble this sensor for repair. A defective unit must be returned to the manufacturer.

Specifications

Sensing Beam

Visible red Class 2 laser, 650 nm

Supply Voltage

10 to 30 V dc (10% max. ripple) at less than 20 mA, exclusive of load

Beam Size at Aperture (Retroreflective Models)

3.75 mm x 1.85 mm (0.15 in x 0.07 in)

Beam Divergence (Retroreflective Models)

Approximately 1 milliradian

Laser Classification

Class 2 safety (CDRH (FDA) 1040.10 and IEC 60875-1)

Supply Protection Circuitry

Protected against reverse polarity, over voltage, and transient voltages

Delay at Power Up

< 1 second

Output Configuration

SPDT (complementary) solid-state switch; choose NPN (current sinking) or PNP (current sourcing) models

Light operate: Normally-open output conducts when the sensor sees its own modulated light

Dark operate: Normally-closed output conducts when the sensor sees dark

Output Rating

150 mA maximum (each output)

OFF-state leakage current: < 1 microamp at 30 V dc

ON-state saturation voltage: < 0.3 V at 10 mA dc; < 0.8 V at 150 mA dc

Output Protection

Protected against continuous overload or short-circuit of outputs;

Overload trip point \geq 220 mA

Output Response Time

0.2 ms (200 μ s) ON and OFF

Repeatability

50 μ s

Adjustments

12-turn slotted brass Gain (sensitivity) adjustment potentiometer (clutched at both ends of travel)

Extinguishing Wire

Gray wire held "low" for laser operation; "high" to turn laser OFF; Low \leq 1.0 V dc; High \geq $V_{supply} - 4.0$ V dc (< 30 V dc) or disconnect wire; 100 ms delay upon enable

Indicators

Two LEDs: green and amber

Green solid: power to sensor is ON

Amber solid: light is sensed; normally open output is conducting

Green flashing: output overloaded

Amber flashing: marginal excess gain

Construction

Housings are heat-resistant ABS/polycarbonate alloy, UL94-VO rated; acrylic lens cover

Environmental Rating

NEMA 3; IEC IP54

Connections

2 m (6.5 ft) or 9 m (30 ft) attached cable, or 5-pin Euro-style 150 mm (6 in) pigtail quick-disconnect fitting; mating cables for QD models are ordered separately

Operating Conditions

Temperature: -10 °C to $+45$ °C (14 °F to 113 °F)

Maximum relative humidity: 90% at 50 °C (non-condensing)

Weight

Sensor only: 22 g (0.8 oz)

Sensor plus 2 m cable: 62 g (2.2 oz)

Application Notes

False pulse may occur < 1 second after power-up

Certifications (all models except PD4* V..C300 Series)



Dimensions

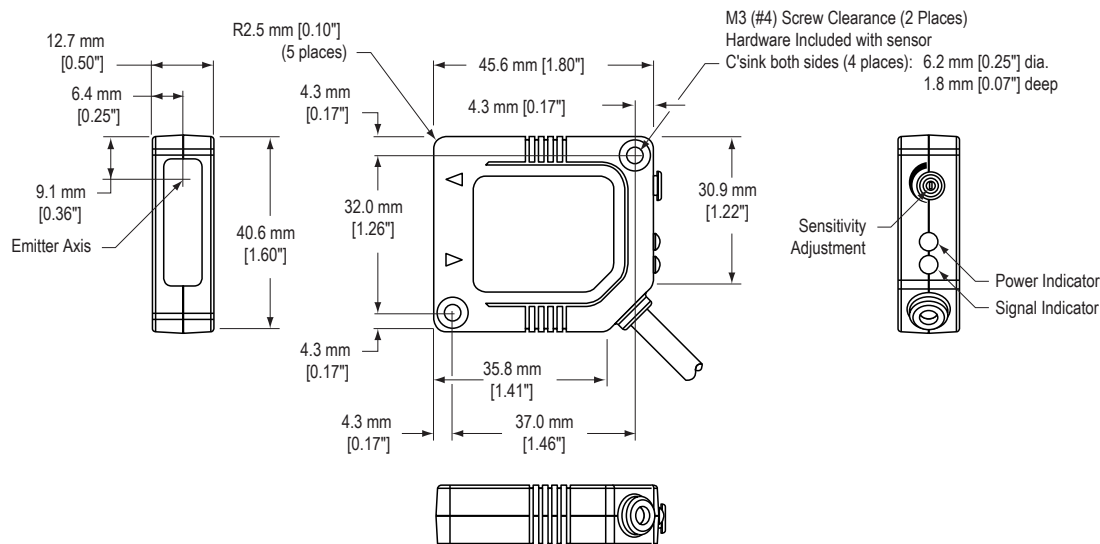

Wiring Diagrams

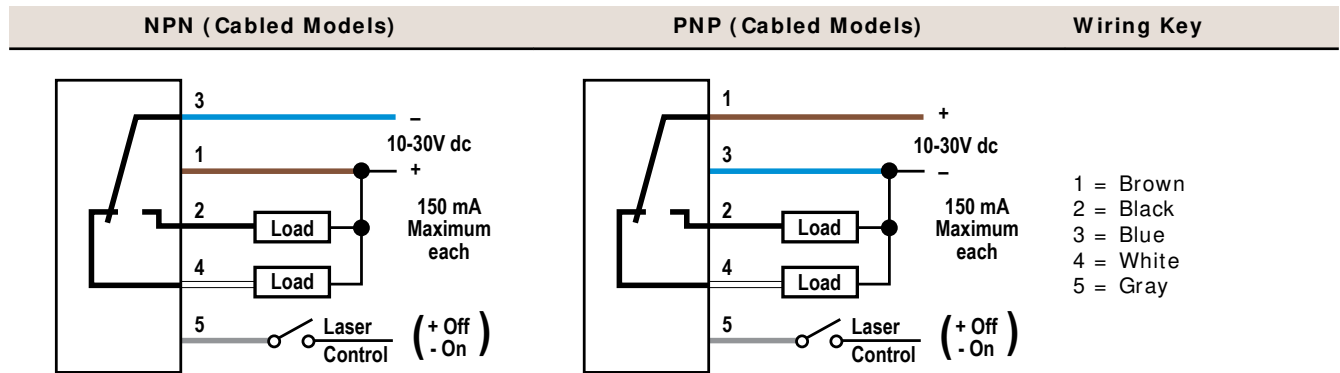

Quick disconnect wiring is functionally the same.

Accessories

5-Pin Threaded M12/ Euro-Style Cordsets—Single Ended				
Model	Length	Style	Dimensions	Pinout (Female)
MQDC1-501.5	0.50 m (1.5 ft)	Straight		<p>1 = Brown 2 = White 3 = Blue 4 = Black 5 = Gray</p>
MQDC1-506	1.83 m (6 ft)			
MQDC1-515	4.57 m (15 ft)			
MQDC1-530	9.14 m (30 ft)			
MQDC1-506RA	1.83 m (6 ft)	Right-Angle		
MQDC1-515RA	4.57 m (15 ft)			
MQDC1-530RA	9.14 m (30 ft)			

Mounting Brackets	
<p>SMB46L</p> <ul style="list-style-type: none"> • Right-angle • L bracket • 14-ga. 316 stainless steel <div style="text-align: center;"> </div> <p>Hole center spacing: A = 16.0</p> <p>Hole size: A = 16.5 × 18.7</p>	<p>SMB46S</p> <ul style="list-style-type: none"> • Right-angle • S bracket • 14-ga. 316 stainless steel <div style="text-align: center;"> </div> <p>Hole center spacing: A = 16.0</p> <p>Hole size: A = 16.5 × 18.7, B = 34.0 × 10.0</p>

Mounting Brackets

SMB46U

- Right-angle
- U bracket for sensor protection
- 14-ga. 316 stainless steel

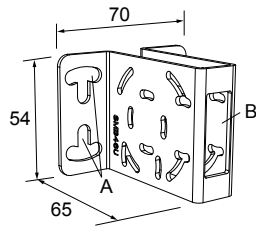

Hole center spacing: A = 16.0

Hole size: A = 16.5 × 18.7, B = 34.0 × 13.0

SMB46A

- 2-piece 12-ga. stainless steel bracket assembly with precision sensor alignment adjustment
- 2 mm hex key included

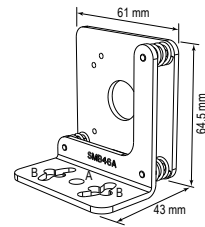

Hole center spacing: A to B = 18.5, B = 30.5

Hole size: A = ø 6.6, B = 7.1 × 20.3

SMB46DF

- Flat bracket holds two sensors at a fixed angle
- Black anodized aluminum

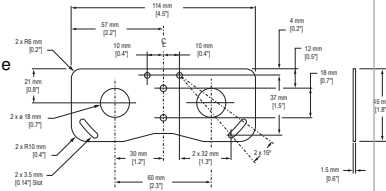

Retroreflectors

BRT-51X51BM

- Square, acrylic target
- Reflectivity Factor: 1.5
- Max. Temperature: +50 °C (+122 °F)
- Micro-prism geometry
- Optional brackets are available
- Approximate size: 51 mm × 51 mm

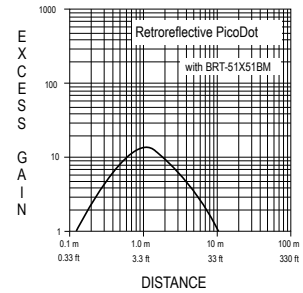
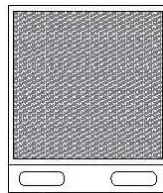

BRT-2X2

- Square, acrylic target
- Reflectivity factor: 1.0
- Max. temperature: +50 °C (+122 °F)
- Optional brackets are available
- Approximate size: 51 mm × 51 mm

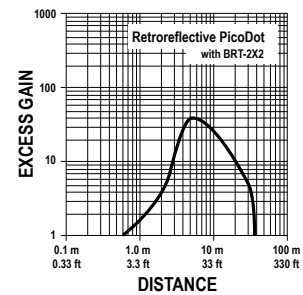
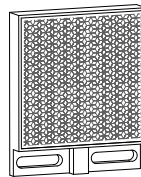

Retroreflectors

Model	Reflectivity Factor	Maximum Temperature	Size
BRT-THG-3X3-10	0.7	+ 60 °C (+ 140 °F)	75 × 75 mm
BRT-THG-4X4-5	0.7	+ 60 °C (+ 140 °F)	100 × 100 mm
BRT-THG-8.5X11-2	0.7	+ 60 °C (+ 140 °F)	216 × 280 mm
BRT-THG-18X36	0.7	+ 60 °C (+ 140 °F)	457 × 914 mm
BRT-THG-1-100	0.7	+ 60 °C (+ 140 °F)	25 mm (1 in) wide, 2.5 m (100 in) long
BRT-THG-2-100	0.7	+ 60 °C (+ 140 °F)	50 mm (2 in) wide, 2.5 m (100 in) long
BRT-THG-3-100	0.7	+ 60 °C (+ 140 °F)	75 mm (3 in) wide, 2.5 m (100 in) long

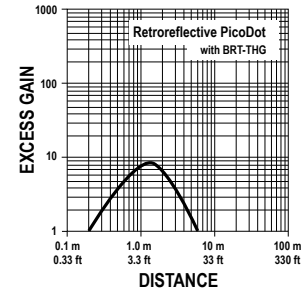

Banner Engineering Corp. Limited Warranty

Banner Engineering Corp. warrants its products to be free from defects in material and workmanship for one year following the date of shipment. Banner Engineering Corp. will repair or replace, free of charge, any product of its manufacture which, at the time it is returned to the factory, is found to have been defective during the warranty period. This warranty does not cover damage or liability for misuse, abuse, or the improper application or installation of the Banner product.

THIS LIMITED WARRANTY IS EXCLUSIVE AND IN LIEU OF ALL OTHER WARRANTIES WHETHER EXPRESS OR IMPLIED (INCLUDING, WITHOUT LIMITATION, ANY WARRANTY OF MERCHANTABILITY OR FITNESS FOR A PARTICULAR PURPOSE), AND WHETHER ARISING UNDER COURSE OF PERFORMANCE, COURSE OF DEALING OR TRADE USAGE.

This Warranty is exclusive and limited to repair or, at the discretion of Banner Engineering Corp., replacement. **IN NO EVENT SHALL BANNER ENGINEERING CORP. BE LIABLE TO BUYER OR ANY OTHER PERSON OR ENTITY FOR ANY EXTRA COSTS, EXPENSES, LOSSES, LOSS OF PROFITS, OR ANY INCIDENTAL, CONSEQUENTIAL OR SPECIAL DAMAGES RESULTING FROM ANY PRODUCT DEFECT OR FROM THE USE OR INABILITY TO USE THE PRODUCT, WHETHER ARISING IN CONTRACT OR WARRANTY, STATUTE, TORT, STRICT LIABILITY, NEGLIGENCE, OR OTHERWISE.**

Banner Engineering Corp. reserves the right to change, modify or improve the design of the product without assuming any obligations or liabilities relating to any product previously manufactured by Banner Engineering Corp.