

Q23s are miniature right-angle sensors

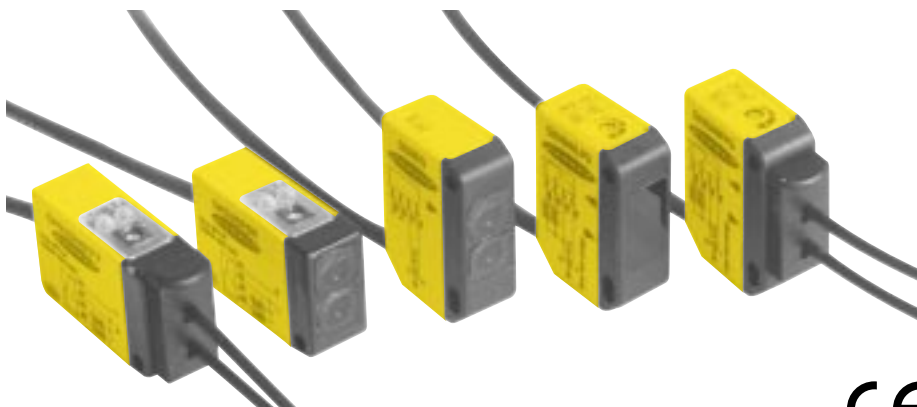

QH23s feature in-line (horizontal) design



Features

- Totally self-contained; 10 to 30V dc operation
- Powerful visible red sensing beam simplifies setup and alignment
- Sensors include self-diagnostic circuitry; one output may be used as a marginal signal alarm[†]
- Circuitry is completely sealed in ABS housing; rated IP67 and NEMA 6
- Choose NPN (sinking) or PNP (sourcing) models; outputs are short circuit protected and rated for up to 150 milliamp load
- LED indications for Power ON, Output Status (including overload condition), Alignment and Marginal Signal
- Stainless steel right-angle mounting bracket and hardware are included (see page 7 and 8)

Q23 Sensing Mode Options

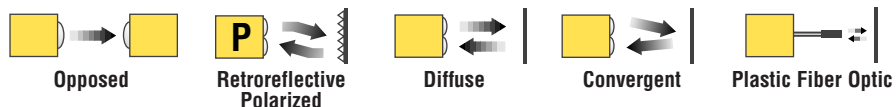

[†] U.S. patent #5087838

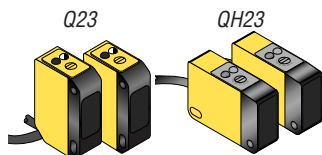

Visible red, 680 nm

Q23 & QH23 Opposed Mode Emitter (E) and Receiver (R)

Models	Range	Cable	Supply Voltage	Output Type	Excess Gain	Beam Pattern
Q236E QH236E Q236EQ QH236EQ	8 m (26ft)	2 m (6.5 ft) 2 m (6.5 ft) 4-Pin Pico QD 4-Pin Pico QD	10-30V dc	Complementary Solid-state NPN		Effective Beam: 5.3 mm
Q23SN6R QH23SN6R Q23SN6RQ QH23SN6RQ		2 m (6.5 ft) 2 m (6.5 ft) 4-Pin Pico QD 4-Pin Pico QD				
Q23SP6R QH23SP6R Q23SP6RQ QH23SP6RQ		2 m (6.5 ft) 2 m (6.5 ft) 4-Pin Pico QD 4-Pin Pico QD				

Q23 and QH23 Series

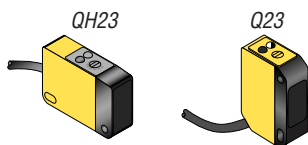

NOTE: Retroreflective range is specified using one model BRT-3 retroreflector (3-inch diameter). Actual sensing range may be more or less than specified, depending upon the efficiency and reflective area of the retroreflector(s) in use. See the Banner Photoelectric Sensors catalog for more information on available retroreflectors.



Visible red, 680 nm

Q23 & QH23 Polarized Retroreflective Mode

Models	Range	Cable	Supply Voltage	Output Type	Excess Gain	Beam Pattern
Q23SN6LP QH23SN6LP Q23SN6LPQ QH23SN6LPQ	100 mm to 2 m (4 to 80 in)	2 m (6.5 ft) 2 m (6.5 ft) 4-Pin Pico QD 4-Pin Pico QD	10-30V dc	Complementary Solid-state NPN		
Q23SP6LP QH23SP6LP Q23SP6LPQ QH23SP6LPQ		2 m (6.5 ft) 2 m (6.5 ft) 4-Pin Pico QD 4-Pin Pico QD		Complementary Solid-state PNP		

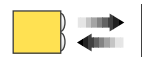
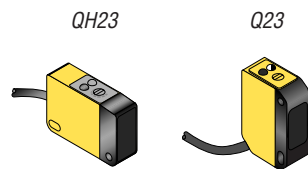

Visible red, 680 nm

Q23 & QH23 Diffuse Mode

Models	Range	Cable	Supply Voltage	Output Type	Excess Gain	Beam Pattern
					Performance based on 90% reflectance white test card	
Short Range						
Q23SN6D QH23SN6D Q23SN6DQ QH23SN6DQ	Optimum: 2 - 50 mm (.1 - 2 in)	2 m (6.5 ft) 2 m (6.5 ft) 4-Pin Pico QD 4-Pin Pico QD	10-30V dc	Complementary Solid-state NPN		
Q23SP6D QH23SP6D Q23SP6DQ QH23SP6DQ	Maximum: 200 mm (8 in)	2 m (6.5 ft) 2 m (6.5 ft) 4-Pin Pico QD 4-Pin Pico QD		Complementary Solid-state PNP		
Long Range						
Q23SN6DL QH23SN6DL Q23SN6DLQ QH23SN6DLQ	Optimum: 30 - 300 mm (1.2 - 12 in)	2 m (6.5 ft) 2 m (6.5 ft) 4-Pin Pico QD 4-Pin Pico QD	10-30V dc	Complementary Solid-state NPN		
Q23SP6DL QH23SP6DL Q23SP6DLQ QH23SP6DLQ	Maximum: 800 mm (32 in)	2 m (6.5 ft) 2 m (6.5 ft) 4-Pin Pico QD 4-Pin Pico QD		Complementary Solid-state PNP		

Q23 and QH23 Series

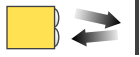

Visible red, 680 nm

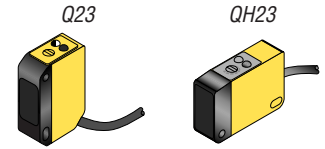

Q23 & QH23 Convergent						
Models	Focus	Cable	Supply Voltage	Output Type	Excess Gain	Beam Pattern
Q23SN6CV50 QH23SN6CV50 Q23SN6CV50Q QH23SN6CV50Q	50 mm (2 in)	2 m (6.5 ft) 2 m (6.5 ft) 4-Pin Pico QD 4-Pin Pico QD	10-30V dc	Complementary Solid-state NPN		
Q23SP6CV50 QH23SP6CV50 Q23SP6CV50Q QH23SP6CV50Q		2 m (6.5 ft) 2 m (6.5 ft) 4-Pin Pico QD 4-Pin Pico QD		Complementary Solid-state PNP		

For All Q23 & QH23 Sensors:

- i) 9 m (30 ft) cables are available by adding suffix “W/30” to the model number of any cabled sensor (e.g. - Q23SN6LP W/30)
- ii) All Q23 QD models have a 4-pin pico-style connector on a 150 mm (6 in) cable pigtail.
- iii) A model with a QD connector requires an optional mating cable. See Accessories for more information.

Q23 and QH23 Series

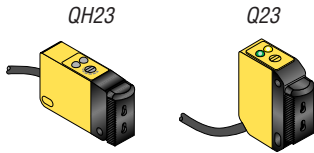

Visible red, 680 nm

Q23 & QH23 Plastic Fiber Optic						
Models	Range	Cable	Supply Voltage	Output Type	Excess Gain	Beam Pattern
					Diffuse mode performance based on 90% reflectance white test card	
Standard Speed: 1 ms Response						
Q23SN6FP QH23SN6FP Q23SN6FPQ QH23SN6FPQ	Range varies by sensing mode and fiber optics used	2 m (6.5 ft) 2 m (6.5 ft) 4-Pin Pico QD 4-Pin Pico QD	10-30V dc	Complementary Solid-state NPN		
Q23SP6FP QH23SP6FP Q23SP6FPQ QH23SP6FPQ		2 m (6.5 ft) 2 m (6.5 ft) 4-Pin Pico QD 4-Pin Pico QD		Complementary Solid-state PNP		
High Speed: 100 µs Response						
Q23SN6FPY QH23SN6FPY Q23SN6FPYQ QH23SN6FPYQ	Range varies by sensing mode and fiber optics used	2 m (6.5 ft) 2 m (6.5 ft) 4-Pin Pico QD 4-Pin Pico QD	10-30V dc	Complementary Solid-state NPN		
Q23SP6FPY QH23SP6FPY Q23SP6FPYQ QH23SP6FPYQ		2 m (6.5 ft) 2 m (6.5 ft) 4-Pin Pico QD 4-Pin Pico QD		Complementary Solid-state PNP		

For Q23 Plastic Fiber Sensing Mode:

- The opposed range of Q23FP sensors using 1 mm (0.4 in) plastic fibers may be extended using optional lens pairs. A pair of model L2 lenses extends the opposed range to 2 m (80 in). A pair of model L08FP lenses extends opposed range to 3 m (10 ft). See the photoelectric sensors catalog for lens details.
- Diffuse mode sensing with Q23FPY models is generally not recommended due to low excess gain. If in doubt about sensing performance, contact the factory Application Engineering Department or your local Banner Sales Engineer to discuss diffuse mode applications.

Q23 and QH23 Series

Q23 & QH23 Product Specifications	
Supply Voltage and Current	10 to 30V dc (10% maximum ripple) at less than 25 mA for diffuse, retro, and fiber optic models (exclusive of load) Opposed emitters and receivers draw 20 mA each
Supply Protection Circuitry	Protected against reverse polarity and transient voltages
Output Configuration	Solid-state dc complementary outputs: Q(H)23SN6xx models = NPN sinking, N.O. (normally open) & N.C. (normally closed) complementary Q(H)23SP6xx models = PNP sourcing, N.O. & N.C. complementary Light operate: N.O. output conducts when the sensor sees its own modulated light source Dark operate: N.C. output conducts when the sensing beam is blocked The N.C. output may be used as an alarm output, depending upon hookup to the power supply (see hookup diagrams)
Output Rating	150 mA maximum each in standard hookup; when wired for alarm output, the total load may not exceed 150 mA Off-state leakage current less than 1 microamp at 30V dc Output saturation voltage less than 1 volt at 10mA dc; less than 1.5V at 150 mA dc
Output Protection Circuitry	Protected against false pulse on power-up, transient voltages, and continuous overload or short-circuit of outputs
Output Response Time	1 millisecond “on” and “off” (except for Q23FPY high-speed sensors which have 100 microsecond response time); no false pulse on power-up (NOTE: 100 millisecond delay on power-up: outputs are non-conducting during this time.)
Repeatability	All Opposed Modes: 0.13 ms; Retro and Diffuse: 0.25 ms; FPY High speed Plastic Fiber Optic: 25 microseconds Response time and repeatability specifications are independent of signal strength.
Adjustments	SENSITIVITY control (single-turn, o-ring sealed potentiometer)
Indicators	Sensors except opposed mode emitters have two LEDs: GREEN glowing steadily = dc power “on” GREEN flashing = output overload YELLOW glowing steadily = normally open output is conducting YELLOW flashing = marginal excess gain (1 - 1.5x), light condition; flashing YELLOW corresponds to “on” state of alarm output Emitters have green power “on” indicator
Construction	Yellow and black ABS housing, with acrylic lens and clear ABS top cover, completely sealed. Stainless steel mounting bracket and M3 mounting hardware are supplied
Environmental Rating	Meets NEMA standards 1, 2, 3, 3S, 4, 4X, 6, 12, and 13; IEC IP67. Housing materials rated UL 94 V-0
Connections	PVC-jacketed 4-conductor 2 m (6.5 ft) or 9 m (30 ft) cables, or 6-inch pigtail with 4-pin pico-style quick disconnect (QD) fitting are available. Mating QD cables are ordered separately. See Accessories.
Operating Temperature	Temperature: -20° to +55°C (-5° to +131°F) Maximum relative humidity: 90% at 50°C (non-condensing)
Application Note	To avoid damage to the sensor caused by static discharge (ESD), use the plastic screwdriver supplied with each sensor (included in the hardware packet) to adjust the SENSITIVITY control. Otherwise, use a screwdriver with an insulated handle.
Certifications	

Quick Disconnect (QD) Option

Q23 & QH23 sensors are sold either with a 2 m (6.5 ft) or 9 m (30 ft) attached PVC-covered cable or with a 4-pin pico-style QD connector on a 150 mm (6 in) cable pigtail.

Q23 & QH23 QD sensors are identified by the letter “Q” in their model number suffix. Mating cables for QD sensors are model PKG4-2 (straight connector) or PKW4-2 (right-angled connector). Cables are supplied in a standard length of 2 m (6.5 ft). For more information on QD cable, see Accessories.

Q23 and QH23 Series

Q23 & QH23 Hookup Diagrams

Sensors with NPN (Sinking) Outputs Standard Hookup

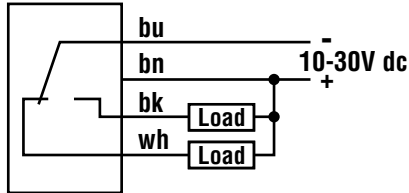

Alarm Hookup

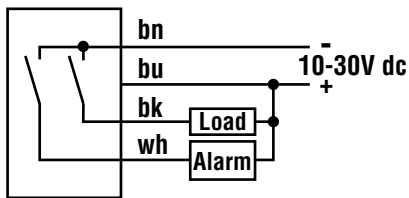

Sensors with PNP (Sourcing) Outputs Standard Hookup

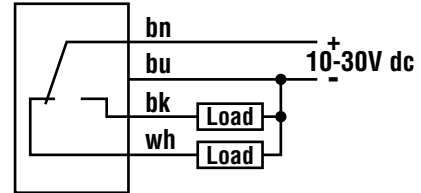

Alarm Hookup

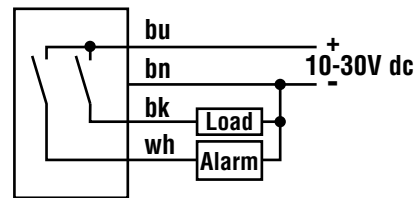

Emitters

Note: No connection to bk and wh wires of QD cable.

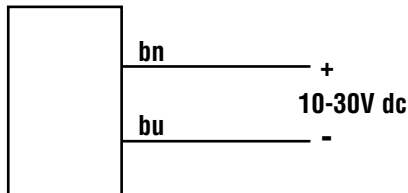

4-Pin Pico-Style Pin-out (Connector on Cable Shown)

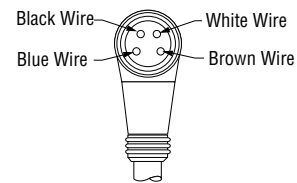

NOTE: Hookups are the same for either an integral or QD cable. QD connector pin configuration is, as follows:

Q23 Pigtail Quick Disconnect

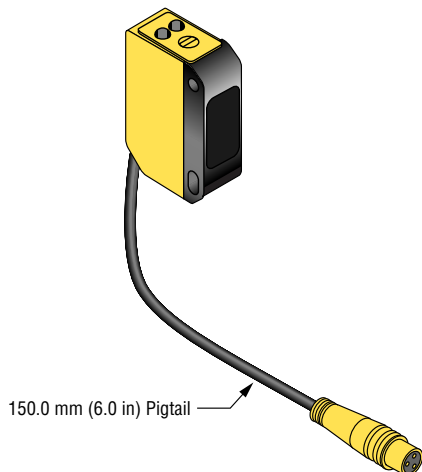

QH23 Pigtail Quick Disconnect

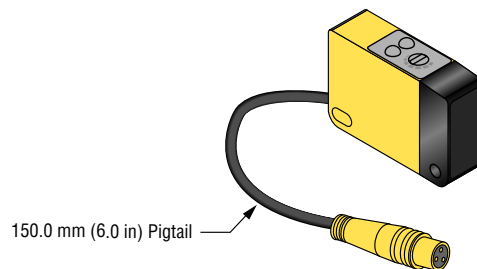

Q23 and QH23 Series

QH23 Dimension Information

QH23 Sensor - Opposed, Diffuse, and Retroreflective Modes (model suffix E, R, D, & LP)

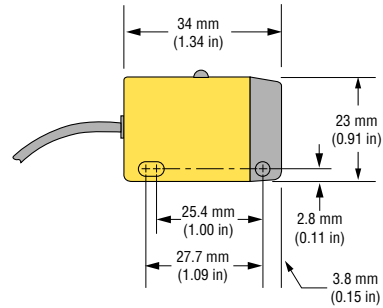
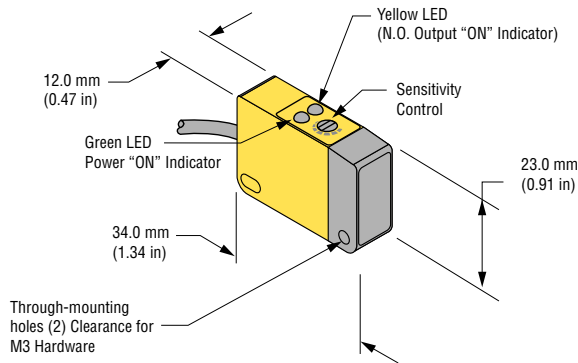

QH23 Sensor - Convergent (model suffix CV)

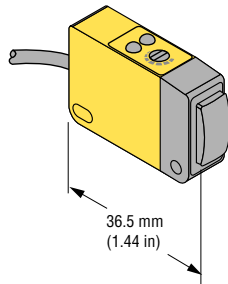

QH23 Sensor - Plastic Fiber Optic (model suffix FP & FPY)

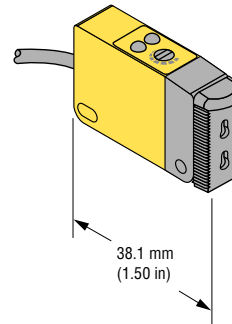

QH23 Mounting Bracket (included with sensor)

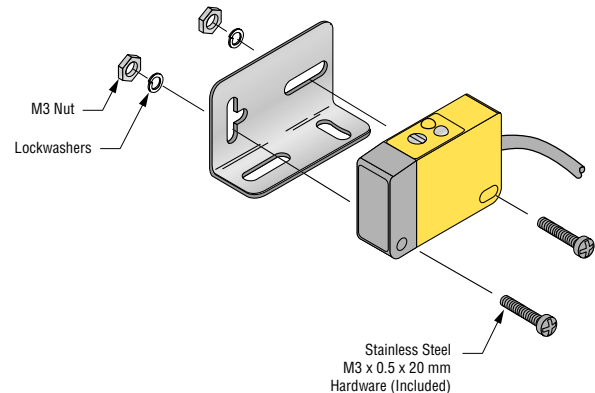
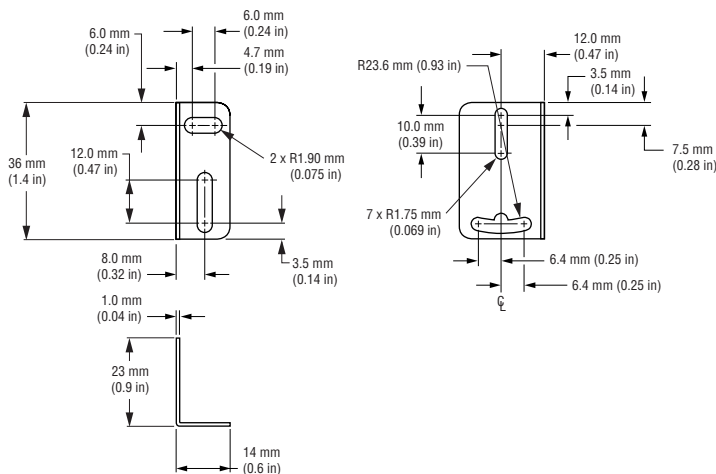

Q23 and QH23 Series

Q23 Accessories

Q23 & QH23 Modifications

Model Suffix	Modification	Description	Example of Model Number
W/30	9 m (30 ft) cable	All Q23 sensors may be ordered with an integral 9 m (30 ft) cable in place of the standard 2 m (6.5 ft) cable	Q23SP6D W/30

Quick Disconnect (QD) Cables

The following is a selection of cables available for the EZ-BEAM QD models

Style	Model	Length	Dimensions
Pico Style straight	PKG4-2	2 m (6.5 ft)	
Pico Style right angle	PKW4-2		

Q23 and QH23 Series

Optional Mounting Bracket Information

SMB46L

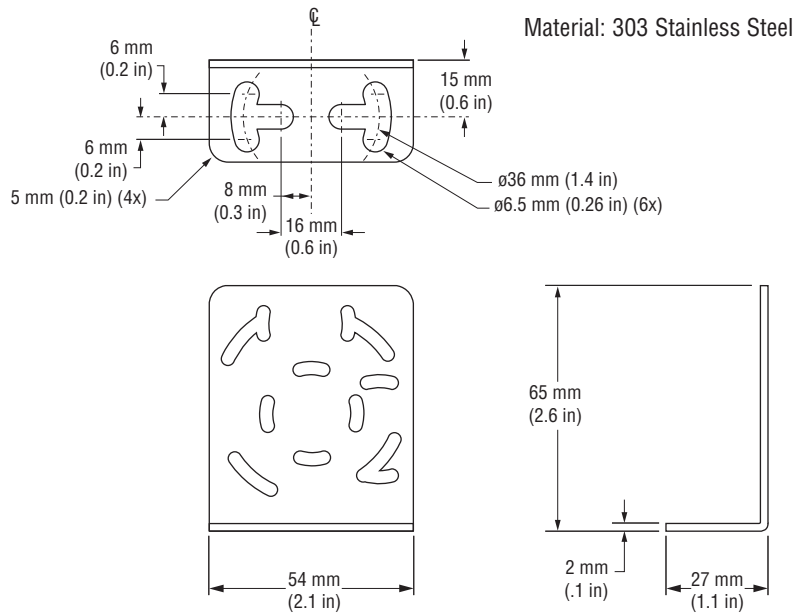
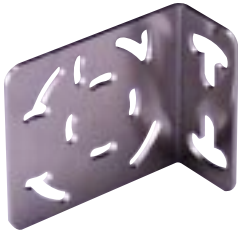

SMB46S

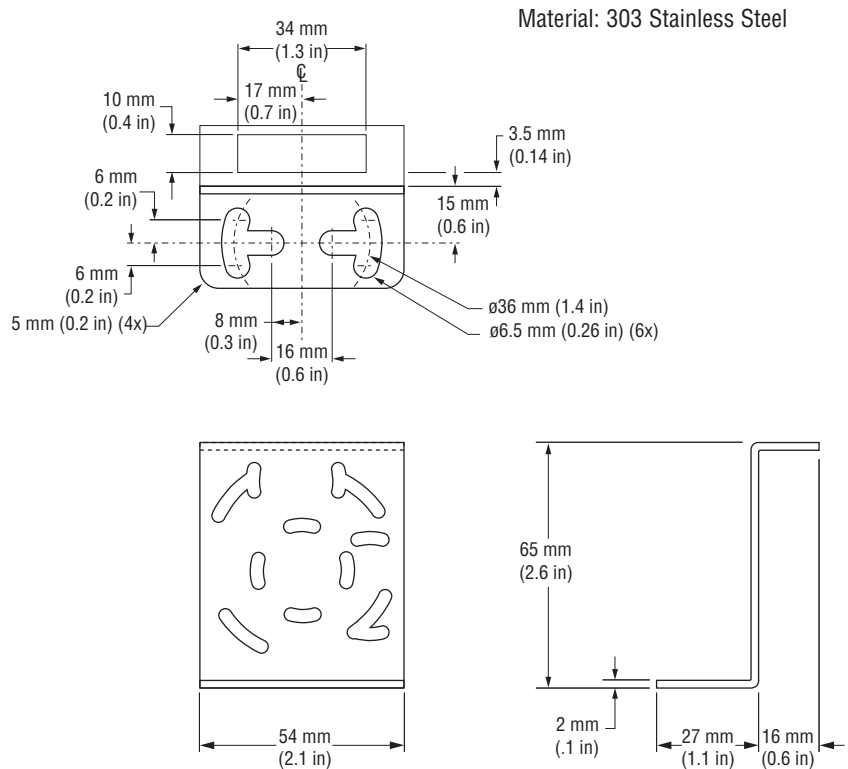

Optional Mounting Bracket Information

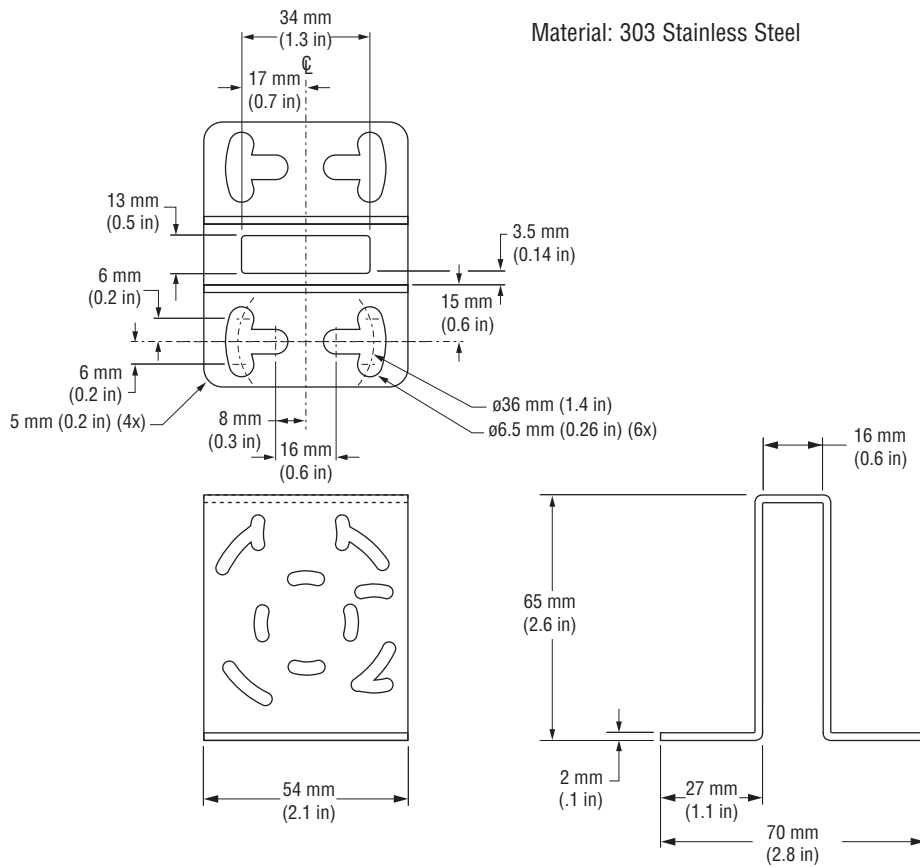

Q23 Mounting Configurations

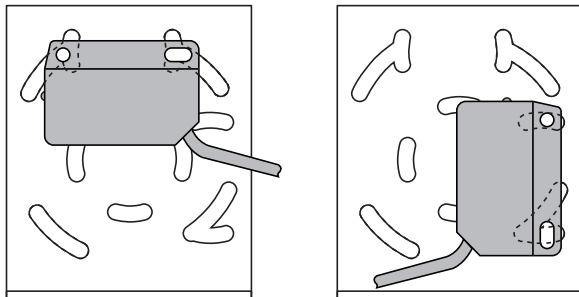

QH23 Mounting Configurations

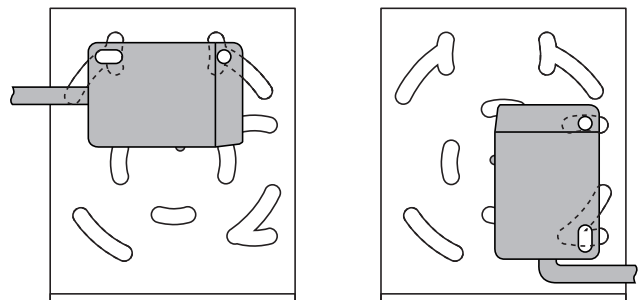

Q23 and QH23 Series



WARRANTY: Banner Engineering Corporation warrants its products to be free from defects for one year. Banner Engineering Corporation will repair or replace, free of charge, any product of its manufacture found to be defective at the time it is returned to the factory during the warranty period. This warranty does not cover damage or liability for the improper application of Banner products. This warranty is in lieu of any other warranty either expressed or implied.



WARNING These photoelectric presence sensors do NOT include the self-checking redundant circuitry necessary to allow their use in personnel safety applications. A sensor failure or malfunction can result in either an energized or a de-energized sensor output condition.

Never use these products as sensing devices for personnel protection. Their use as a safety device may create an unsafe condition which could lead to serious injury or death.

Only MICRO-SCREEN™, MINI-SCREEN®, MULTI-SCREEN®, MACHINE-GUARD™ and PERIMETER-GUARD™ Systems, and other systems so designated, are designed to meet OSHA and ANSI machine safety standards for point-of-operation guarding devices. No other Banner sensors or controls are designed to meet these standards, and they must NOT be used as sensing devices for personnel protection.