

Q4X Stainless Steel Analog Laser Sensor



Quick Start Guide

Class 1 laser CMOS analog sensor with an analog output. Patent pending.

This guide is designed to help you set up and install the Q4X Analog Sensor. For complete information on programming, performance, troubleshooting, dimensions, and accessories, please refer to the Instruction Manual at www.bannerengineering.com. Search for p/n 185624 to view the Instruction Manual. Use of this document assumes familiarity with pertinent industry standards and practices.

For illustration purposes, the threaded barrel model Q4X images are used throughout this document.



WARNING:

- **Do not use this device for personnel protection**
- Using this device for personnel protection could result in serious injury or death.
- This device does not include the self-checking redundant circuitry necessary to allow its use in personnel safety applications. A device failure or malfunction can cause either an energized (on) or de-energized (off) output condition.

Features

Figure 1. Sensor Features—Threaded Barrel Models

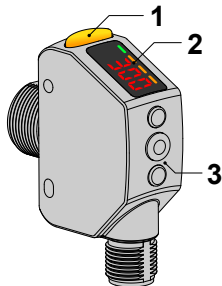

1. Output Indicator (Amber)
2. Display
3. Buttons

Figure 2. Sensor Features—Flush Mount Models

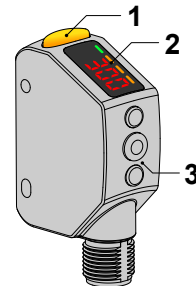

Display and Indicators

The display is a 4-digit, 7-segment LED. The main screen is the Run Mode screen, which shows the current distance to the target in millimeters.

Figure 3. Display in Run Mode

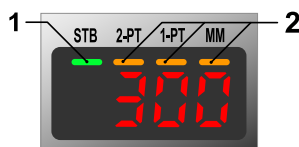

1. Stability Indicator (STB = Green)
2. Active TEACH Indicators
 - 2-PT = Two-Point TEACH (Amber)
 - 1-PT = One-Point TEACH (Amber)
3. Display Value Indicator (MM = Amber)

Output Indicator

- On—Displayed distance is within the taught analog output window
- Off—Displayed distance is outside of the taught analog output window

Active TEACH Indicators (2PT and 1PT)

- 2-PT on—Two-point TEACH mode selected (default)
- 1-PT on—One-point TEACH mode selected

Stability Indicator (STB)

- On—Stable signal within the specified sensing range
- Flashing—Marginal signal, the target is outside of the limits of the specified sensing range, or a multiple peak condition exists
- Off—No target detected within the specified sensing range

Display Value Indicator (MM)

- On—Display shows the distance in millimeters (default)
- Off—Display shows the analog output value

Buttons

Use the sensor buttons (**SELECT**)(**TEACH**), **(+)**(**DISP**), and **(-)**(**MODE**) to program the sensor.



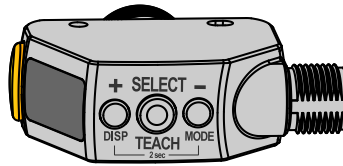

(SELECT)(TEACH)

- Press and hold for longer than 2 seconds to start the currently selected TEACH mode (the default is two-point TEACH)
- Press to select menu items in Setup mode

(-)(MODE)

- Press to change the distance setting for the 0 V (4 mA) point; press and hold to decrease numeric values
- Press and hold for longer than 2 seconds to enter Setup mode
- Press to navigate the sensor menu in Setup mode

(+)(DISP)

- Press to change the distance setting for the 10 V (20 mA) point; press and hold to increase numeric values
- Press and hold for longer than 2 seconds to toggle the display value between the distance and the analog output
- Press to navigate the sensor menu in Setup mode



Note: When navigating the menu, the menu items loop.

Laser Description and Safety Information



CAUTION:

- **Return defective units to the manufacturer.**
- Use of controls or adjustments or performance of procedures other than those specified herein may result in hazardous radiation exposure.
- Do not attempt to disassemble this sensor for repair. A defective unit must be returned to the manufacturer.

≤ 510 mm Models - IEC 60825-1:2007 Class 1 Laser

Class 1 lasers are lasers that are safe under reasonably foreseeable conditions of operation, including the use of optical instruments for intrabeam viewing.

COMPLIES WITH 21 CFR 1040.10 AND 1040.11 EXCEPT FOR DEVIATIONS PURSUANT TO LASER NOTICE No. 50, DATED JUNE 24, 2007. BANNER ENGINEERING CORP. 9714 10TH AVENUE NORTH MINNEAPOLIS, MN 55441	<div style="border: 1px solid black; padding: 5px; width: fit-content; margin: 0 auto;"> CLASS 1 LASER PRODUCT </div> COMPLIES WITH IEC 60825-1:2007
---	--

Laser wavelength: 655 nm

Output: < 0.20 mW

Pulse Duration: 7 μs to 2 ms

> 510 mm Models - IEC 60825-1:2014 Class 1 Laser

Class 1 lasers are lasers that are safe under reasonably foreseeable conditions of operation, including the use of optical instruments for intrabeam viewing.

COMPLIES WITH 21 CFR 1040.10 AND 1040.11 EXCEPT FOR CONFORMANCE WITH IEC 60825-1:2014, AS DESCRIBED IN LASER NOTICE No. 56, DATED MAY 8, 2019. BANNER ENGINEERING CORP. 9714 10TH AVENUE NORTH MINNEAPOLIS, MN 55441	<div style="border: 1px solid black; padding: 5px; width: fit-content; margin: 0 auto;"> CLASS 1 LASER PRODUCT </div> COMPLIES WITH IEC 60825-1:2014
---	--

Laser wavelength: 655 nm

Output: < 0.39 mW

Pulse Duration: 7 μs to 2 ms

Installation

Install the Safety Label

The safety label must be installed on Q4X sensors that are used in the United States.



Note: Position the label on the cable in a location that has minimal chemical exposure.

1. Remove the protective cover from the adhesive on the label.
2. Wrap the label around the Q4X cable, as shown.
3. Press the two halves of the label together.

Figure 4. Safety Label Installation

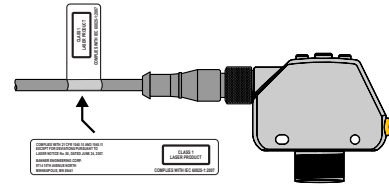

Sensor Orientation

Optimize detection reliability and performance with correct sensor-to-target orientation. To ensure reliable detection, orient the sensor as shown in relation to the target to be detected.

Figure 5. Optimal Orientation of Target to Sensor

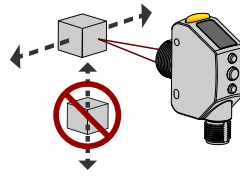

See the following figures for examples of correct and incorrect sensor-to-target orientation as certain placements may pose problems for sensing some targets.

Figure 6. Orientation by a wall

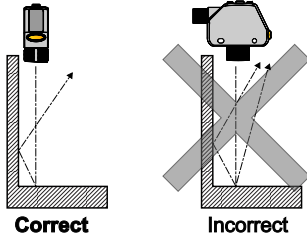

Figure 7. Orientation for a turning object

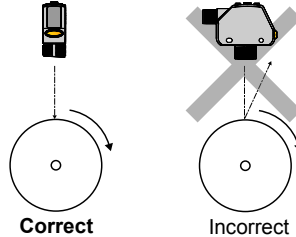

Figure 8. Orientation for a height difference

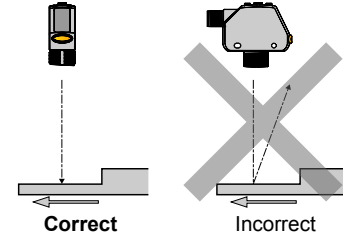

Figure 9. Orientation for a color or luster difference

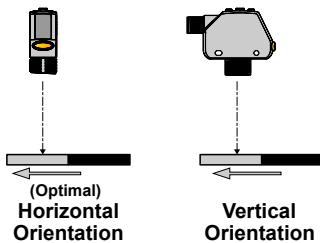
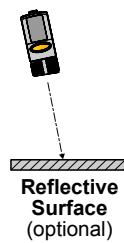

Figure 10. Orientation for highly reflective target[‡]



Mount the Device

1. If a bracket is needed, mount the device onto the bracket.
2. Mount the device (or the device and the bracket) to the machine or equipment at the desired location. Do not tighten the mounting screws at this time.
3. Check the device alignment.
4. Tighten the mounting screws to secure the device (or the device and the bracket) in the aligned position.

[‡] Applying tilt to sensor may improve performance on reflective targets. The direction and magnitude of the tilt depends on the application, but a 15° tilt is often sufficient.

Wiring Diagram

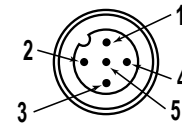
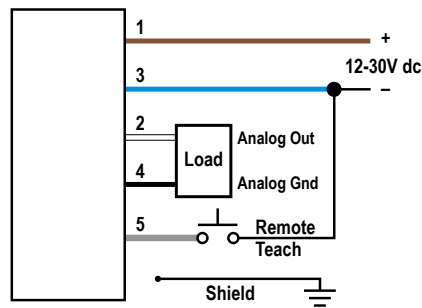

Key

- 1 = Brown
- 2 = White
- 3 = Blue
- 4 = Black
- 5 = Gray



Note: Open lead wires must be connected to a terminal block.



Note: The input wire function is user-selectable; see the Instruction Manual for details. The default for the input wire function is off (disabled).



Note: Shielded cordsets are recommended for all models with quick disconnect fittings. It is recommended that the shield wire be connected to -V DC (the blue wire).

Cleaning and Maintenance

Clean the sensor when soiled and use with care.

Handle the sensor with care during installation and operation. Sensor windows soiled by fingerprints, dust, water, oil, etc. may create stray light that may degrade the peak performance of the sensor. Blow the window clear using filtered, compressed air, then clean as necessary using only water and a lint-free cloth.

Connecting to RSD1

The following diagram depicts the connection of the Q4XTULAF600, Q4XTILAF600, Q4XTULAF610, or Q4XTILAF610 to the optional RSD1 accessory.

Figure 11. Q4X to RSD1

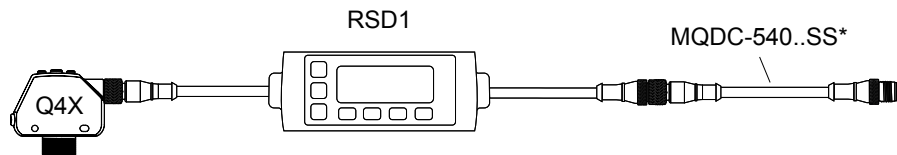

*Optional Extension Cordset: MQDEC3-5..SS

Sensor Programming

Program the sensor using the buttons on the sensor or the remote input (limited programming options).

In addition to programming the sensor, use the remote input to disable the buttons for security, preventing unauthorized or accidental programming changes. See the Instruction Manual, p/n 185624 for more information.

Setup Mode

1. Access Setup mode and the sensor menu from Run mode by pressing and holding **MODE** for longer than 2 seconds.
2. Use **+** and **-** to navigate through the menu.
3. Press **SELECT** to select a menu option and access the submenus.
4. Use **+** and **-** to navigate through the submenus.
5. Select a submenu option.
 - Press **SELECT** to select a submenu option and return to the top menu.
 - Press and hold **SELECT** for longer than 2 seconds to select a submenu option and return immediately to Run mode.

To exit Setup mode and return to Run mode, navigate to **End** and press **SELECT**.

Figure 12. Sensor Menu Map

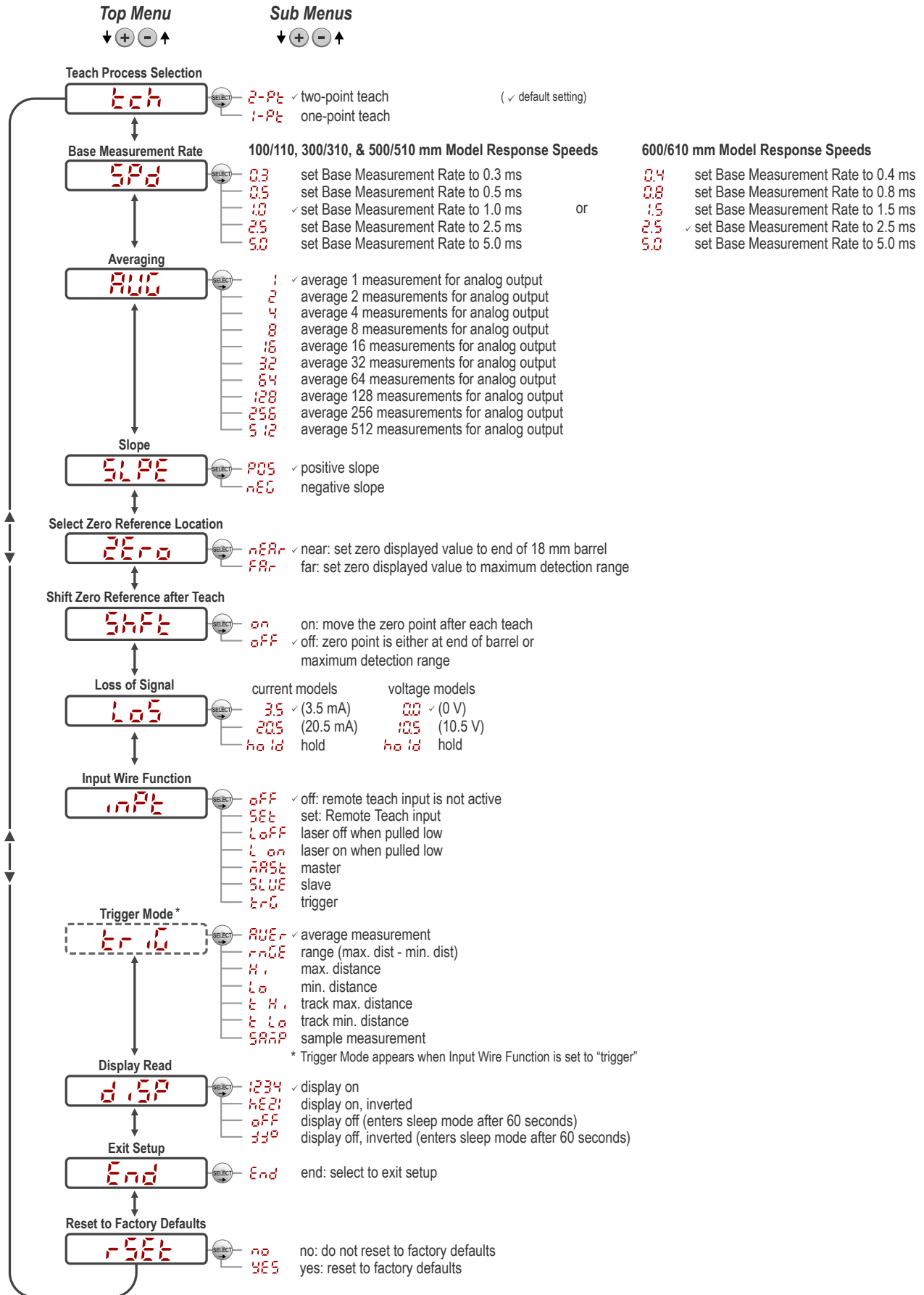



Basic TEACH Instructions

Use the following instructions to teach the Q4X sensor. The instructions provided on the sensor display vary depending on the type of TEACH mode selected. Two-point TEACH is the default TEACH mode.

1. Press and hold **TEACH** for longer than 2 seconds to start the selected TEACH mode.
2. Present the target.
3. Press **TEACH** to teach the target. The target is taught and the sensor waits for the second target, if required by the selected TEACH mode, or returns to Run mode.
Complete steps 4 and 5 only if required for the selected TEACH mode:
4. Present the second target.
5. Press **TEACH** to teach the target. The target is taught and the sensor returns to Run mode.

Manual Adjustments

Manually adjust the distance set for the 0 V (4 mA) and 10 V (20 mA) values using the  and  buttons. The available adjustments vary depending on the TEACH mode selected.

Locking and Unlocking the Sensor Buttons







Use the lock and unlock feature to prevent unauthorized or accidental programming changes.

Three settings are available:

- **wLoc** —The sensor is unlocked and all settings can be modified (default).
- **Loc** — The sensor is locked and no changes can be made.
- **OLoc** —The value associated with 0 V (4 mA) and 10 V (20 mA) can be changed by teaching or manual adjustment, but no sensor settings can be changed through the menu.

When in **Loc** mode, **Loc** displays when the **(SELECT)(TEACH)** button is pressed. The analog point displays when **(+)(DISP)** or **(-)(MODE)** are pressed, but **Loc** displays if the buttons are pressed and held.

When in **OLoc** mode, **Loc** displays when **(+)(DISP)** or **(-)(MODE)** are pressed and held. To access the manual adjust options, briefly press and release **(+)(DISP)** or **(-)(MODE)**. To enter TEACH mode, press the **(SELECT)(TEACH)** button and hold for longer than 2 seconds.

To enter **Loc** mode, hold  and press  four times. To enter **OLoc** mode, hold  and press  seven times. Holding  and pressing  four times unlocks the sensor from either lock mode and the sensor displays **wLoc**.

Specifications

Sensing Beam using Visible red Class 1 laser, 655 nm

≤ 510 mm models: IEC 60825-1:2007 Class 1
 > 510 mm models: IEC 60825-1:2014 Class 1

Supply Voltage (Vcc)

12 V DC to 30 V DC

Power and Current Consumption, exclusive of load

< 675 mW

Sensing Range—Threaded Barrel Models

600 mm models: 25 mm to 600 mm (0.98 in to 23.62 in)
500 mm models: 25 mm to 500 mm (0.98 in to 19.68 in)
300 mm models: 25 mm to 300 mm (0.98 in to 11.81 in)
100 mm models: 25 mm to 100 mm (0.98 in to 3.94 in)

Sensing Range—Flush Mount Models

610 mm models: 35 mm to 610 mm (1.38 in to 24.02 in)
310 mm models: 35 mm to 310 mm (1.38 in to 12.20 in)
110 mm models: 35 mm to 110 mm (1.38 in to 4.33 in)

Analog Output Configuration

0 V to 10 V or 4 mA to 20 mA, depending on model

Output Rating

Analog Voltage Outputs (Q4X..U Models): 2.5 kOhm minimum load resistance

Analog Current Outputs (Q4X..I Models): 1 kΩ maximum load resistance at 24 V; maximum load resistance = $[(V_{cc} - 4.5)/0.02 \Omega]$

Remote Input

Allowable Input Voltage Range: 0 to Vcc

Active Low (internal weak pullup—sinking current): Low State < 2.0 V at 1 mA max.

Supply Protection Circuitry

Protected against reverse polarity and transient overvoltages

Analog Resolution—Threaded Barrel Models

300 mm and 600 mm models:
 25 mm to 100 mm: < 0.3 mm
 100 mm to 300 mm: < 1 mm
500 mm models only: 300 to 500 mm: < 1.75 mm
600 mm models only: 300 to 600 mm: < 2 mm
100 mm models: 25 mm to 100 mm: < 0.15 mm

Analog Resolution—Flush Mount Models

610 mm models: 310 to 610 mm: < 2 mm
310 mm models:
 35 mm to 110 mm: < 0.3 mm
 110 mm to 310 mm: < 1 mm
110 mm models: 35 mm to 110 mm: < 0.15 mm

Beam Spot Size—300/310 mm, 500 mm, and 600/610 Models

Table 1: Beam Spot Size—300/310 mm, 500 mm, and 600/610 mm Models

Distance (mm)		Size (Horizontal × Vertical)
Threaded Barrel Models	Flush Mount Models	
25	35	2.6 mm × 1.0 mm
150	160	2.3 mm × 0.9 mm
300	310	2.0 mm × 0.8 mm
500	-	1.9 mm × 1.0 mm
600	610	1.9 mm × 1.0 mm

Analog Linearity

Analog linearity performance matches accuracy performance curve (see [Performance Curves—Threaded Barrel Models](#) on page 9 and [Performance Curves—Flush Mount Models](#) on page 10).

On 600 mm and 610 mm models, linearity is the lesser of accuracy or 2.5% of full scale range

Response Speed

Total response speed varies from 0.5 ms to 2560 ms, depending on base measurement rate and averaging settings. See Instruction Manual for more information.

Delay at Power Up

< 750 ms

Ambient Light Immunity

> 5,000 lux at 300 mm
 > 2,000 lux at 500 mm

Maximum Torque

Side mounting: 1 N·m (9 in·lbs)
Nose mounting: 20 N·m (177 in·lbs)

Connector

Integral 5-pin M12 male quick-disconnect connector

Construction

Housing: 316 L stainless steel
Lens cover: PMMA acrylic
Lightpipe and display window: polysulfone

Chemical Compatibility

Compatible with commonly used acidic or caustic cleaning and disinfecting chemicals used in equipment cleaning and sanitation. ECOLAB® certified. Compatible with typical cutting fluids and lubricating fluids used in machining centers

Application Note

For optimum performance, allow 10 minutes for the sensor to warm up

Beam Spot Size—100/110 mm Models

Table 2: Beam Spot Size—100/110 mm Models

Distance (mm)		Size (Horizontal × Vertical)
Threaded Barrel Models	Flush Mount Models	
25	35	2.4 mm × 1.0 mm
50	60	2.2 mm × 0.9 mm
100	110	1.8 mm × 0.7 mm

Excess Gain using a 90% White Card—600/610 mm Models

Table 3: *HIGH* Excess Gain (*Std* Excess Gain²)

Response Speed (ms)	· at 25 mm (600 mm models)	· at 100 mm (600 mm models)	· at 300 mm (600 mm models)	· at 600 mm (600 mm models)
	· at 35 mm (610 mm models)	· at 110 mm (610 mm models)	· at 310 mm (610 mm models)	· at 610 mm (610 mm models)
2	280	110	25	6
5	280	110	25	6
15	1000 (360)	400 (150)	80 (30)	20 (7)
25	2000 (1000)	800 (400)	160 (80)	40 (20)
50	4000 (2000)	1600 (800)	320 (160)	80 (40)

Environmental Rating

IP67 per IEC60529
 IP68 per IEC60529
 IP69K per DIN 40050-9 per DIN40050-9

Shock

MIL-STD-202G, Method 213B, Condition I (100G 6x along X, Y, and Z axes, 18 shocks), with device operating

Vibration

MIL-STD-202G, Method 201A (Vibration: 10 Hz to 60 Hz, 0.06 inch (1.52 mm) double amplitude, 2 hours each along X, Y and Z axes), with device operating

Storage Temperature

-25 °C to +75 °C (-13 °F to +167 °F)

Operating Conditions

35% to 95% relative humidity

Vcc	Min. Ambient Temp (°C)	Max. Ambient Temp (°C)	
	All Models	Q4X...U (0–10V)	Q4X..I (4–20 mA)*
12	-10	50	50
24			45
30			40

* For 4–20 mA models only: Max. Ambient Sensor Temp (°C) = 50 – (Vcc – 12)/2

Required Overcurrent Protection



WARNING: Electrical connections must be made by qualified personnel in accordance with local and national electrical codes and regulations.

Overcurrent protection is required to be provided by end product application per the supplied table.

Overcurrent protection may be provided with external fusing or via Current Limiting, Class 2 Power Supply.

Supply wiring leads < 24 AWG shall not be spliced.

For additional product support, go to www.bannerengineering.com.

Supply Wiring (AWG)	Required Overcurrent Protection (Amps)
20	5.0
22	3.0
24	2.0
26	1.0
28	0.8
30	0.5

Certifications



Banner Engineering Europe Park Lane, Culliganlaan 2F bus 3, 1831 Diegem, BELGIUM



Turck Banner LTD Blenheim House, Blenheim Court, Wickford, Essex SS11 8YT, Great Britain



Industrial Control Equipment
3TJJ

Class 2 power

UL Environmental Rating: Type 1



chemical compatibility certified

ECOLAB is a registered trademark of Ecolab USA Inc. All rights reserved.

FCC Part 15

This device complies with Part 15 of the FCC Rules. This equipment generates, uses, and can radiate radio frequency energy and, if not installed and used in accordance with the instruction manual, may cause harmful interference to radio communications.

Operation is subject to the following two conditions: 1) This device may not cause harmful interference; and 2) This device must accept any interference received, including interference that may cause undesired operation.

Industry Canada

This device complies with CAN ICES-3 (A)/NMB-3(A). Operation is subject to the following two conditions: 1) This device may not cause harmful interference; and 2) This device must accept any interference received, including interference that may cause undesired operation.

Cet appareil est conforme à la norme NMB-3(A). Le fonctionnement est soumis aux deux conditions suivantes : (1) ce dispositif ne peut pas occasionner d'interférences, et (2) il doit tolérer toute interférence, y compris celles susceptibles de provoquer un fonctionnement non souhaité du dispositif.

²
 · *Std* excess gain available in 15 ms response speed only
 · *Std* excess gain provides increased noise immunity

Performance Curves—Threaded Barrel Models

Accuracy (90% to 6% reflectance)

Figure 13. 100 mm Models

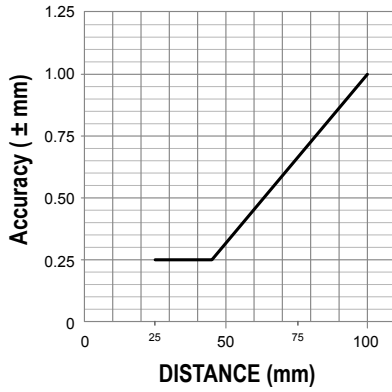

Figure 14. 300 mm Models

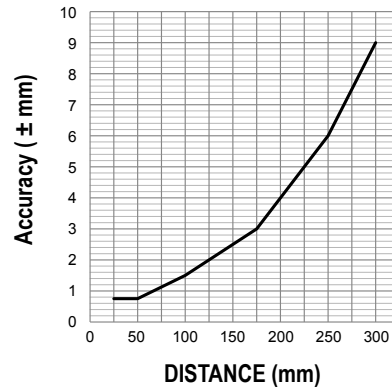

Figure 15. 500 mm Models

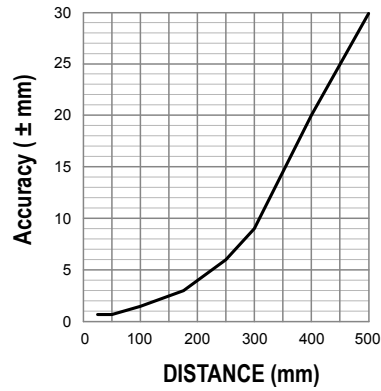
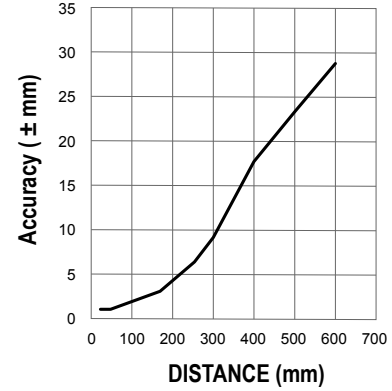

Figure 16. 600 mm Models



Repeatability (90% to 6% reflectance)

Figure 17. 100 mm Models

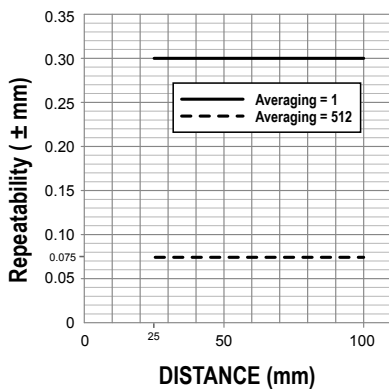
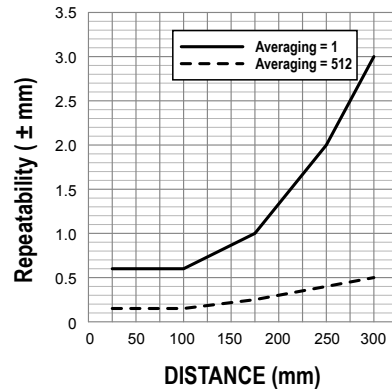

Figure 18. 300 mm Models



Repeatability (90% to 6% reflectance)

Figure 19. 500 mm Models

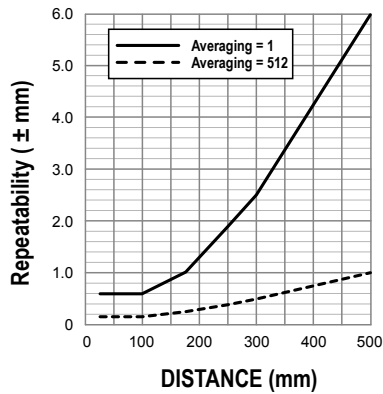
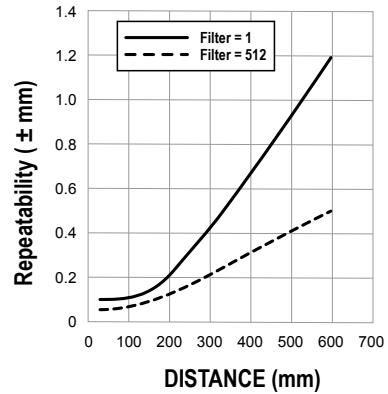

Figure 20. 600 mm Models



Typical Temperature Effects³

Figure 21. 100 mm and 300 mm Models

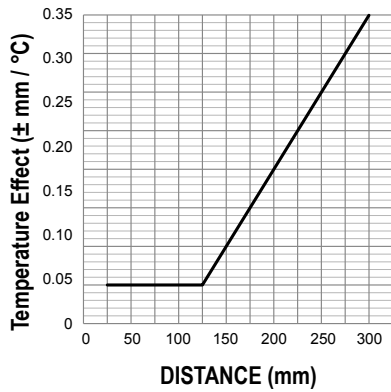

Figure 22. 500 mm Models

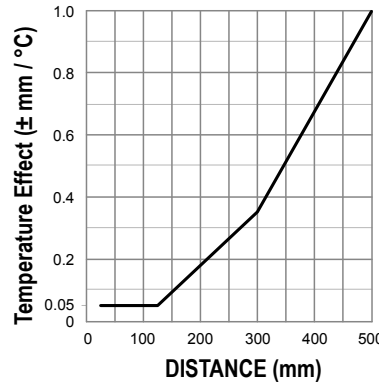
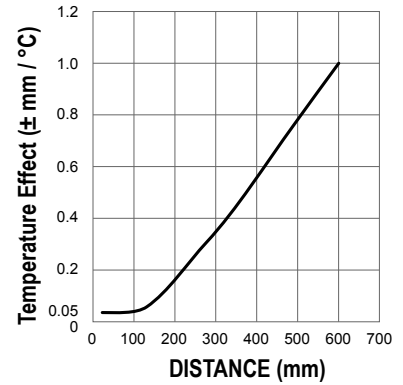

Figure 23. 600 mm Models



Performance Curves—Flush Mount Models

Accuracy (90% to 6% reflectance)

Figure 24. 110 mm Models

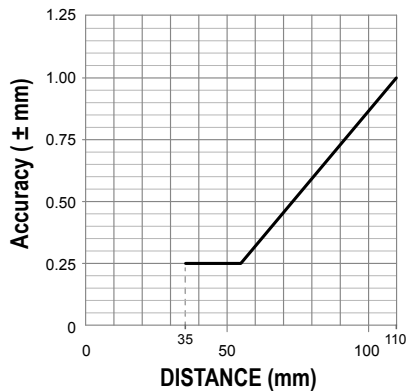

Figure 25. 310 mm Models

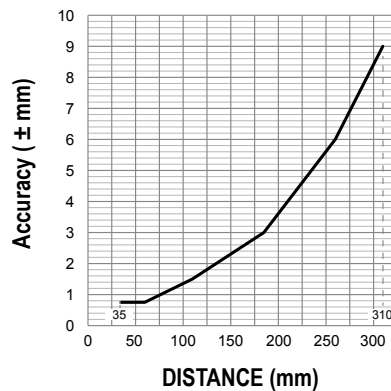
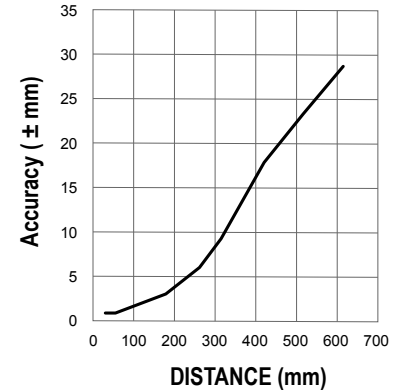

Figure 26. 610 mm Models



³ Calculated as an average temperature effect across the sensor's full operating temperature.

Repeatability (90% to 6% reflectance)

Figure 27. 110 mm Models

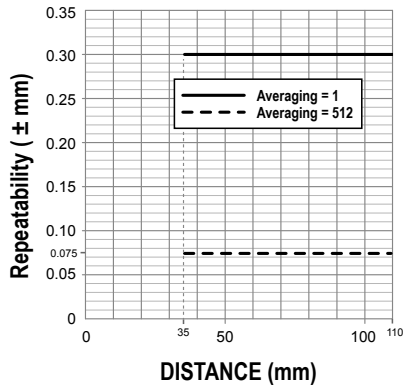

Figure 28. 310 mm Models

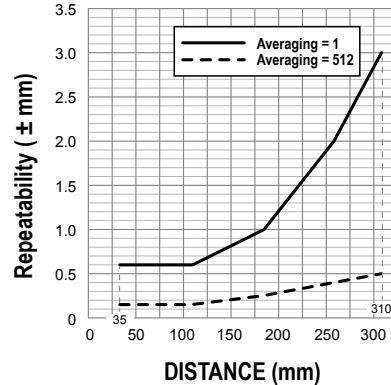
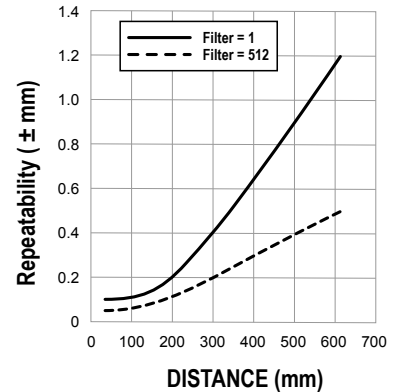

Figure 29. 610 mm Models



Typical Temperature Effects ⁴

Figure 30. 110 mm and 310 mm Models

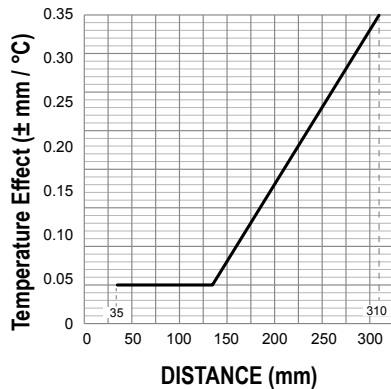
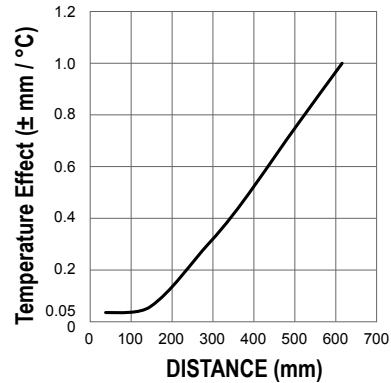

Figure 31. 610 mm Models



Banner Engineering Corp. Limited Warranty

Banner Engineering Corp. warrants its products to be free from defects in material and workmanship for one year following the date of shipment. Banner Engineering Corp. will repair or replace, free of charge, any product of its manufacture which, at the time it is returned to the factory, is found to have been defective during the warranty period. This warranty does not cover damage or liability for misuse, abuse, or the improper application or installation of the Banner product.

THIS LIMITED WARRANTY IS EXCLUSIVE AND IN LIEU OF ALL OTHER WARRANTIES WHETHER EXPRESS OR IMPLIED (INCLUDING, WITHOUT LIMITATION, ANY WARRANTY OF MERCHANTABILITY OR FITNESS FOR A PARTICULAR PURPOSE), AND WHETHER ARISING UNDER COURSE OF PERFORMANCE, COURSE OF DEALING OR TRADE USAGE.

This Warranty is exclusive and limited to repair or, at the discretion of Banner Engineering Corp., replacement. **IN NO EVENT SHALL BANNER ENGINEERING CORP. BE LIABLE TO BUYER OR ANY OTHER PERSON OR ENTITY FOR ANY EXTRA COSTS, EXPENSES, LOSSES, LOSS OF PROFITS, OR ANY INCIDENTAL, CONSEQUENTIAL OR SPECIAL DAMAGES RESULTING FROM ANY PRODUCT DEFECT OR FROM THE USE OR INABILITY TO USE THE PRODUCT, WHETHER ARISING IN CONTRACT OR WARRANTY, STATUTE, TORT, STRICT LIABILITY, NEGLIGENCE, OR OTHERWISE.**

Banner Engineering Corp. reserves the right to change, modify or improve the design of the product without assuming any obligations or liabilities relating to any product previously manufactured by Banner Engineering Corp. Any misuse, abuse, or improper application or installation of this product or use of the product for personal protection applications when the product is identified as not intended for such purposes will void the product warranty. Any modifications to this product without prior express approval by Banner Engineering Corp will void the product warranties. All specifications published in this document are subject to change; Banner reserves the right to modify product specifications or update documentation at any time. Specifications and product information in English supersede that which is provided in any other language. For the most recent version of any documentation, refer to: www.bannerengineering.com.

For patent information, see www.bannerengineering.com/patents.

⁴ Calculated as an average temperature effect across the sensor's full operating temperature.