

# R55F Fiber-Optic Color Mark Sensors

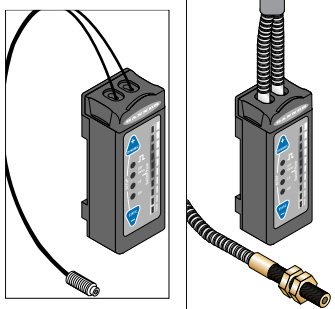

## Datasheet

For Plastic and Glass Fiber Optics



- Outstanding color contrast sensitivity; detects 16 levels of gray scale
- Depending on beam color, reliably detects the toughest color mark contrasts, including 20% yellow against white
- Fast, 50 microsecond response
- Choose from infrared or one of four visible beam colors: red, blue, green and white
- Fibers mount in small and otherwise inaccessible areas
- Easy push-button configuration options include Static TEACH, Static Single-Point TEACH, Dynamic TEACH and Remote TEACH
- Manual sensitivity adjustment
- Non-volatile memory
- Glass fiber models function well in harsh environments typically associated with printing processes
- Plastic fiber models function well in applications that require repeated flexing of the fibers
- Fibers install quickly without tools
- Bipolar (NPN/PNP) outputs with three Delay settings (0, 20 or 40 milliseconds)
- Choice of integral cable or quick disconnect models
- Mounts flat or to 35 mm DIN rail; two brackets included with sensor (one for angle mount, one for flat mount)



### WARNING:

- **Do not use this device for personnel protection**
- Using this device for personnel protection could result in serious injury or death.
- This device does not include the self-checking redundant circuitry necessary to allow its use in personnel safety applications. A device failure or malfunction can cause either an energized (on) or de-energized (off) output condition.

## Models—Glass Fiber-Optic Sensors

Advantages of glass fiber optics for color mark sensing:

- Randomly mixed bifurcated fiber bundles produce the best optics for color mark sensing
- Bundle of small fibers may be shaped at sensing end tip to match the color mark shape
- Best chemical resistance

Model	Color	Maximum Sensing Distance (for black-to-white contrast)	Cable <sup>1</sup>	Output Type
R55FV	Visible red, 650 nm	0.060-in diameter bundle: 28 mm (1.1 in)	5-wire 2 m (6.5 ft) cable	Bipolar NPN/PNP
R55FVQ		0.125-in diameter bundle: 110 mm (4.3 in)	5-pin M12/Euro-style male quick disconnect	
R55FVG	Visible green, 525 nm	0.060-in diameter bundle: 12 mm (0.5 in)	5-wire 2 m (6.5 ft) cable	
R55FVGQ		0.125-in diameter bundle: 50 mm (2.0 in)	5-pin M12/Euro-style male quick disconnect	
R55FVB	Visible blue, 475 nm	0.060-in diameter bundle: 12 mm (0.5 in)	5-wire 2 m (6.5 ft) cable	
R55FVBQ		0.125-in diameter bundle: 50 mm (2.0 in)	5-pin M12/Euro-style male quick disconnect	
R55FW	Visible white, 450 nm to 650 nm	0.060-in diameter bundle: 12 mm (0.5 in)	5-wire 2 m (6.5 ft) cable	
R55FWQ		0.125-in diameter bundle: 50 mm (2.0 in)	5-pin M12/Euro-style male quick disconnect	
R55F	Infrared, 880 nm	0.060-in diameter bundle: 40 mm (1.6 in)	5-wire 2 m (6.5 ft) cable	
R55FQ		0.125-in diameter bundle: 140 mm (5.5 in)	5-pin M12/Euro-style male quick disconnect	

## Models—Plastic Fiber-Optic Sensors

Advantages of plastic fiber optics for color mark sensing:

- Plastic fibers may be repeatedly flexed
- Low cost
- Most models may be cut to fit in the field

Model	Color	Maximum Sensing Distance (for black-to-white contrast)	Cable <sup>2</sup>	Supply Voltages	Output Type
R55FP	Visible red, 650 nm	0.040-in diameter fibers: 60 mm (2.4 in)	5-wire 2 m (6.5 ft) cable	10 V DC to 30V DC	Bipolar NPN/PNP
R55FPQ			5-pin M12/Euro-style male quick disconnect		
R55FPG	Visible green, 525 nm	0.040-in diameter fibers: 28 mm (1.1 in)	5-wire 2 m (6.5 ft) cable		
R55FPGQ			5-pin M12/Euro-style male quick disconnect		
R55FPB	Visible blue, 475 nm	0.040-in diameter fibers: 28 mm (1.1 in)	5-wire 2 m (6.5 ft) cable		
R55FPBQ			5-pin M12/Euro-style male quick disconnect		
R55FPW	Visible white, 450 nm to 650 nm	0.040-in diameter fibers: 28 mm (1.1 in)	5-wire 2 m (6.5 ft) cable		
R55FPWQ			5-pin M12/Euro-style male quick disconnect		

<sup>1</sup> To order the 9 m (30 ft) PVC cable model, add the suffix "W/30" to the cabled model number. For example, R55FV W/30. Models with a quick disconnect require a mating cordset.

<sup>2</sup> To order the 9 m (30 ft) PVC cable model, add the suffix "W/30" to the cabled model number. For example, R55FP W/30. Models with a quick disconnect require a mating cordset.



## Overview

The R55F Fiber-Optic Sensor was developed to provide simplicity of operation and access to tight areas for color mark (registration) sensing applications.

R55F sensors feature TEACH sensitivity adjustment, by presenting the light and the dark sensing conditions to the sensor. In addition, sensitivity may be fine-tuned at any time by clicking the + or - buttons on the sensor. The ten-element signal strength light bar clearly displays the relative received signal strength.

The bipolar (one NPN and one PNP) outputs may be configured to include a 20- or 40-millisecond pulse stretcher (OFF Delay), if required. Both TEACH sensitivity adjustment and output setup are accomplished using the push-buttons on the sensor, or by supplying input pulses using the remote line.

TEACH mode has two options: Static TEACH and Dynamic TEACH. Static TEACH is used to manually set the two sensing conditions individually or to configure a specific condition to be sensed (single-point TEACH adjustment). Dynamic TEACH provides a means for adjusting a series of conditions on-the-fly; the R55F averages the sensing events and automatically sets the switch point between light and dark conditions, and periodically updates it via the adaptive threshold feature.

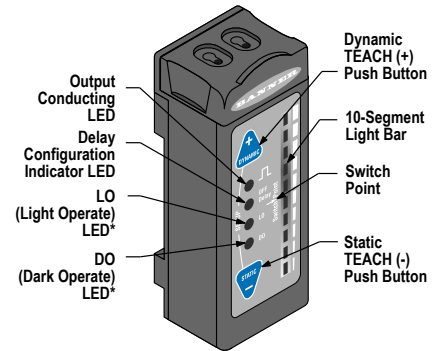

\* Either LO or DO LED is ON whenever sensor has power and is in RUN mode

Figure 1. Features

## Installation

### Install Glass Fibers



**Note:** See Figure 2 on p. 2 for the location of the fiber clip.

1. Verify that a rubber o-ring is pre-installed on each fiber control end.
2. Slide the fiber clip to the open position (A).
3. Insert one fiber end into each port (B).
4. Push firmly on the fiber ends to compress the o-rings and align the grooves in the fiber ends with the slot in the fiber clip.
5. Slide the fiber clip back into place, locking the fibers into position (C).

### Install Plastic Fibers

R55F sensors accept 0.75 mm, 1.0 mm, and 1.5 mm (0.03-in, 0.04-in, and 0.06-in) core diameter plastic fibers.

1. Cut the control ends (sensor ends) of the plastic fiber(s) to the desired length per the procedure that accompanies the fiber assembly.
2. If it has not already been done, separate bifurcated fibers by approximately 51 mm (2 in) from the control ends.
3. Slide the fiber clip to the open position (A).

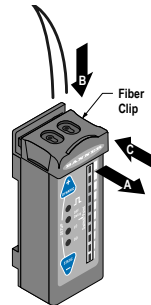

Figure 2. Installing Fibers into the R55F Sensor

4. Insert the fiber ends into each port and push them in as far as they will go (B).
5. Slide the fiber clip back into place, locking the fibers into position (C).

## Mounting Considerations

Mount the sensing end of the fiber optic assembly so that the light image is totally contained within the boundaries of the color mark to be sensed. The light image is made smaller by moving the sensing tip closer to the surface of the material to be sensed.

When sensing marks on shiny (specular) materials, such as metal, plastic or glossy paper, mount the sensing tip of the fiber at approximately 15° from perpendicular to the material surface to minimize strong direct reflections.

Isolate the fiber mounting from vibration. Also, maintain mechanical stability of the surface to be sensed (for example, stabilize web flutter at the sensing point).

## Wiring Diagrams

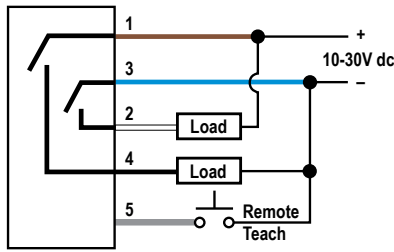

- Key
- 1 = Brown
  - 2 = White
  - 3 = Blue
  - 4 = Black
  - 5 = Gray

Quick disconnect wiring diagrams are functionally identical.

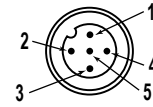

Figure 3. 5-pin M12/Euro Male

## Run Mode

Normal operation of the R55F is called Run mode. See the following table for the behavior of the LED indicators in Run mode.

LED	Operation in Run Mode	
Output Conducting LED	ON when outputs are active	
Delay Configuration Indicator LED	OFF—No OFF Delay is configured ON—20-ms or 40-ms OFF Delay is configured	
Light Operate LED	ON to indicate Light Operate configuration	Because either one of these is always ON when the sensor is operating, the combined Light/Dark Operate LEDs also provide a functional Power-ON indication.)
Dark Operate LED	ON to indicate Dark Operate configuration	
10-Segment Light Bar	Indicates signal strength, with respect to the sensing threshold (Switch Point)	

## TEACH Methods

The sensitivity of the R55F may be quickly optimized by using one of two available TEACH methods: Static TEACH or Dynamic TEACH. Either may be performed using the push buttons on the sensor, or remotely, using a remote switch or process controller connected to the sensor's gray wire. Either a sensing window or a specific point may be configured.

### Remote Configuration

The gray wire of the R55F may be connected to a remote switch or to a process controller to:

- Set sensitivity via either Static or Dynamic TEACH method
- Set output response via Setup mode
- Disable the push button functions

A remote configuration switch is connected between the gray wire and DC common (see Wiring Diagrams). The switch may be either a normally-open contact, or an open-collector NPN transistor with its emitter connected to DC common.

Remote configuration is accomplished using a specified sequence of input pulses. The duration of each pulse is defined as: **0.04 seconds < T < 0.8 seconds (40 ms < T < 800 ms)**

### Static TEACH Method

During a Static TEACH adjustment, the sensor learns the light condition and the dark condition, each one time. Sensitivity is automatically set to place the switch point midway between the two conditions. In addition, the condition configured first becomes the output ON condition.

Sensitivity may be adjusted at any time when the sensor is in Run mode by clicking the + and - buttons. Each click translates to 1/2 segment on the signal strength light bar. For best sensing reliability, the light and dark conditions should register equally distant from the switch point on the signal strength light bar.

### Single-Point TEACH Adjustment

The R55F sensor also may be configured using a single specific target, using an alternate Static TEACH adjustment procedure. The sensor will sense only the configured mark and will ignore signals both stronger and weaker. The sensitivity to the configured mark then may be adjusted up or down.

### Static TEACH Adjustment

1. Enter TEACH mode.

Method	Action	Result
Push Button	Press and hold the STATIC button until the LO and DO indicators alternately flash, then release button.	LO and DO Indicator: Alternately flash green  Indicator: ON amber (indicating ready to configure the output ON condition) Light Bar: Turns OFF
Remote Input	No action required.	

2. Configure the first condition (Output ON state).

Method	Action	Result
<b>Push Button</b>	a. Present the output ON sensing condition. b. Single-click the STATIC button.	LO and DO Indicator: Alternately flash green  Indicator: OFF (indicating ready to configure the output OFF condition) Light Bar: Remains OFF
<b>Remote Input</b>	a. Present the output ON sensing condition to the fiber sensing end. b. Pulse the remote input once.	

### 3. Configure the second condition (Output OFF state).

Method	Action	Result
<b>Push Button</b>	a. Present the output OFF sensing condition. b. Single-click the STATIC button.	<b>Contrast accepted:</b> One of the ten segments flashes for three seconds to indicate relative contrast, and then the sensor enters Run mode. <b>Contrast too low:</b> Every other segment flashes for three seconds to indicate low contrast, and the sensor returns to configure Condition #1.
<b>Remote Input</b>	a. Wait a minimum of 8 seconds after the pulse in step 2. b. Present the output OFF condition. c. Pulse the remote input once.	If the sensing contrast is adequate, the sensor flashes one segment of the signal strength light bar for 3 seconds to indicate relative contrast, and then enters Run mode. If contrast is too low, the sensor flashes five segments of the signal strength light bar in unison to warn of unacceptably low contrast, and returns to reconfigure the Output ON condition.

**Note:** For the push button method:

- The sensor returns to Run mode if either configured condition is not registered within 90 seconds. To cancel TEACH mode, press and hold the push button for  $\geq 2$  seconds. In either case, the sensor reverts to the previous conditions (that is, exit without save).
- If the sensing conditions are accepted at the end of configuring the second condition, the signal strength light bar flashes one of its ten segments for three seconds to indicate relative sensing contrast. The higher the flashing segment, the higher the measured sensing contrast. High contrast relates directly to sensing reliability. High contrast sensing applications are most tolerant of sensing variables, such as web flutter or variations in color mark color or print density.

## Static Single-Point TEACH Adjustment

### 1. Enter TEACH mode.

Method	Action	Result
<b>Push Button</b>	Press and hold the STATIC button until the LO and DO indicators alternately flash, then release button.	LO and DO Indicator: Alternately flash green  Indicator: ON amber (indicating ready to configure the output ON condition) Light Bar: Turns OFF
<b>Remote Input</b>	No action required.	

### 2. Configure the condition to be sensed.

Method	Action	Result
<b>Push Button</b>	a. Present the output ON sensing condition. b. Double-click the STATIC button.	LO and DO Indicator: Depends on the condition configured.  Indicator: OFF Light Bar: Two center segments are ON if the adjustment was successful.
<b>Remote Input</b>	a. Present the output ON sensing condition to the fiber sensing end. b. Pulse the remote input once. c. Wait for a minimum of 0.8 seconds. d. Double-pulse the remote input.	If the configuration is successful, the sensor flashes the middle two LEDs of the bar graph, and returns to Run mode.

- Push Button:** Manually adjust the sensitivity by clicking either the + or - button; the bar graph will flash two segments centered about the sensing point. If the sensitivity is increased (-), the two lighted segments will become closer together, and farther apart if the sensitivity is decreased (+). If the segments do not flash while the sensitivity is being adjusted, the setting has reached its maximum and cannot be adjusted further.

## Dynamic TEACH Method

Use Dynamic TEACH to configure sensitivity during actual machine run conditions. During a Dynamic TEACH adjustment, the sensor samples many color marks against their background material and automatically sets the sensitivity at the optimum level. Dynamic TEACH activates the sensor's adaptive threshold system, which continuously tracks minimum and maximum signal levels, and automatically maintains centering of the switch point between the light and dark conditions. The adaptive threshold system remains in effect during Run mode to automatically adjust for changes in the light or the dark conditions.

When using Dynamic TEACH to configure sensitivity, the output ON state must be assigned to either the light or dark condition using the Setup mode.

To adjust Sensitivity at any time when the sensor is in Run mode, click the "+" and "-" buttons. However, when a manual adjustment is made, the adaptive threshold system is disabled (cancelled).

## Dynamic TEACH Adjustment

## 1. Enter Dynamic TEACH Mode.

Method	Action	Result
Push Button	Press and hold the DYNAMIC button until the LO and DO indicators alternately flash, then release the button.	LO and DO Indicator: Alternately flash green  Indicator: OFF Light Bar: Turns OFF
Remote Input	Hold the remote input low for > 2 seconds.	

## 2. Begin configuring the sensor.

Method	Action	Result
Push Button	Continue to press DYNAMIC button while sampling light and dark sensing conditions.	LO and DO Indicator: Alternately flash green  Indicator: OFF Light Bar: Remains OFF
Remote Input	Continue holding the remote input low while presenting light and dark sensing conditions.	

## 3. Finish configuring the sensor.

Method	Action	Result
Push Button	Release the DYNAMIC button when finished sampling light and dark sensing conditions.	<b>Contrast accepted:</b> One of the ten segments flashes for three seconds to indicate relative contrast, and the sensor enters Run mode. <b>Contrast too low:</b> Five light bar segments flash for three seconds to indicate low contrast, and sensor reverts to the previously configured conditions.
Remote Input	Open the switch when finished configuring.	If the sensing contrast is adequate, the sensor flashes one segment of the signal strength light bar for 3 seconds to indicate relative contrast, and then enters Run mode. If the sensing contrast is too low, the sensor flashes five segments of the signal strength light bar in unison to warn of unacceptably low contrast, and returns to Run mode with its previously configured conditions.

 **Note:** For the push button method:

- If the sensing conditions are accepted at the end of Dynamic TEACH adjustment, the signal strength light bar flashes one of its ten segments for three seconds to indicate relative sensing contrast. The higher the flashing segment, the higher the measured sensing contrast. High contrast relates directly to sensing reliability. High contrast sensing applications are most tolerant of sensing variables, such as web flutter or variations in color mark color or print density.
- If the sensor does not measure enough contrast at the end of Dynamic TEACH adjustment, every other segment of the signal strength light bar flashes in unison for three seconds to warn of unacceptably low contrast, and the sensor returns to Run mode with its previously configured conditions.

## Setup Mode

Setup mode is used to configure sensor output response for:

- Light or Dark operate
- 20- or 40-millisecond pulse stretcher (OFF delay), if required

It is necessary to access Setup mode only if the settings which result from the TEACH configuration are not the settings required for the application. The status LEDs indicate the output response configuration when the sensor is in Run mode, as follows:

- LO indicator ON = Output is light operate
- DO indicator ON = Output is dark operate
- OFF Delay indicator ON = either 20- or 40-millisecond delay is configured
- OFF Delay indicator OFF = no output delay is configured

To change the output response settings:

- Press and hold both push buttons simultaneously until the signal strength light bar turns OFF.
- Click either push button to toggle through the six possible settings indicated as follows:

Table 1: Output Configuration Choices

Output Configuration	Delay Indicator	LO Indicator	DO Indicator
Light operate with no delay	OFF	ON	OFF
Light operate with 20 ms delay	Flashing	ON	OFF
Light operate with 40 ms delay	ON	ON	OFF
Dark operate with no delay	OFF	OFF	ON
Dark operate with 20 ms delay	Flashing	OFF	ON
Dark operate with 40 ms delay	ON	OFF	ON

## 3. Press and hold both push buttons until the signal strength light bar turns ON, indicating return to Run mode.

 **Note:** If Setup mode configuration is interrupted and remains inactive for 30 seconds, the sensor returns to Run mode with the most recent settings (that is, exit and save current selection).

Remote Setup Mode

1. To enter Setup mode, pulse once, wait 0.04 to 0.8 seconds, then pulse again.
2. Wait > 0.8 seconds, then enter sequential pulses to toggle between the six output configuration choices (see Table 1 on p. 5). The spacing between sequential pulses must be > 0.8 seconds.
3. To exit Setup mode, hold the remote input low for > 2 seconds.

Push Button Enable/Disable

Pulse the remote line four times to disable (or to enable) the push buttons.

Specifications

Supply Input

10 V DC to 30 V DC (10% maximum ripple) at less than 70 mA, exclusive of load

Supply Protection Circuitry

Protected against reverse polarity and transient voltages

Output Configuration

Bipolar (NPN and PNP)

Output Rating

150 mA maximum each output at 25 °C (derate ≈ 1 mA per °C increase)

OFF-state leakage current: < 5 μA at 30 V DC

ON-state saturation voltage:

PNP Output < 1 V at 10 mA and 1.5 V at 150 mA

NPN Output < 200 mV at 10 mA and 1 V at 150 mA

Output Protection Circuitry

Protected against output short-circuit, continuous overload, and false pulse on power-up

Output Response

50 microseconds

100 millisecond delay on power-up; outputs do not conduct during this time.

Adjustments

Using the push buttons + Dynamic and - Static:

Manually adjust Switch Point using + or - buttons

Dynamic TEACH (configure on-the-fly) sensitivity adjustment

Static TEACH sensitivity adjustment

Light operate/Dark operate

OFF Delay select: 0 milliseconds, 20 milliseconds, or 40 milliseconds

Using Remote Input (gray wire):

Dynamic TEACH (configure on-the-fly) sensitivity adjustment

Static TEACH sensitivity adjustment

Light operate/Dark operate

OFF Delay select: 0 milliseconds, 20 milliseconds, or 40 milliseconds

Push button lockout for security

Indicator LEDs

10-segment (green) light bar indicates signal strength

Light Operate (green)

Dark Operate (green)

Outputs Conducting  (yellow)

OFF Delay (green):

Table 2: OFF Delay LED Status

Setup Mode	Run Mode
OFF—no delay	OFF—no delay
Flashing—20 ms delay	ON—20 or 40 ms Delay
ON—40 ms delay	

Construction

**Housing:** Black ABS/polycarbonate blend; nylon fiber clip mounts to 35 mm DIN rail  
1 stainless steel right angle bracket and 1 PBT polyester bracket for mounting to flat surfaces also included with sensor

Environmental Rating

IEC IP67; NEMA 6

Connections

**Power:** 2 m or 9 m PVC-jacketed 5-conductor cable or 5-pin Euro-style quick-disconnect (QD) connector

**Fibers:** Fiber clip (no tool required)

Operating Conditions

-10 °C to +55 °C (+14 °F to +131 °F)

90% at +50 °C maximum relative humidity (non-condensing)

Application Notes

Do not mount the fiber tip directly perpendicular to shiny surfaces; position it at approximately a 15° angle in relation to the sensing target  
Minimize web or product flutter whenever possible to maximize sensing reliability

Certifications



Dimensions

All measurements are listed in millimeters [inches], unless noted otherwise.

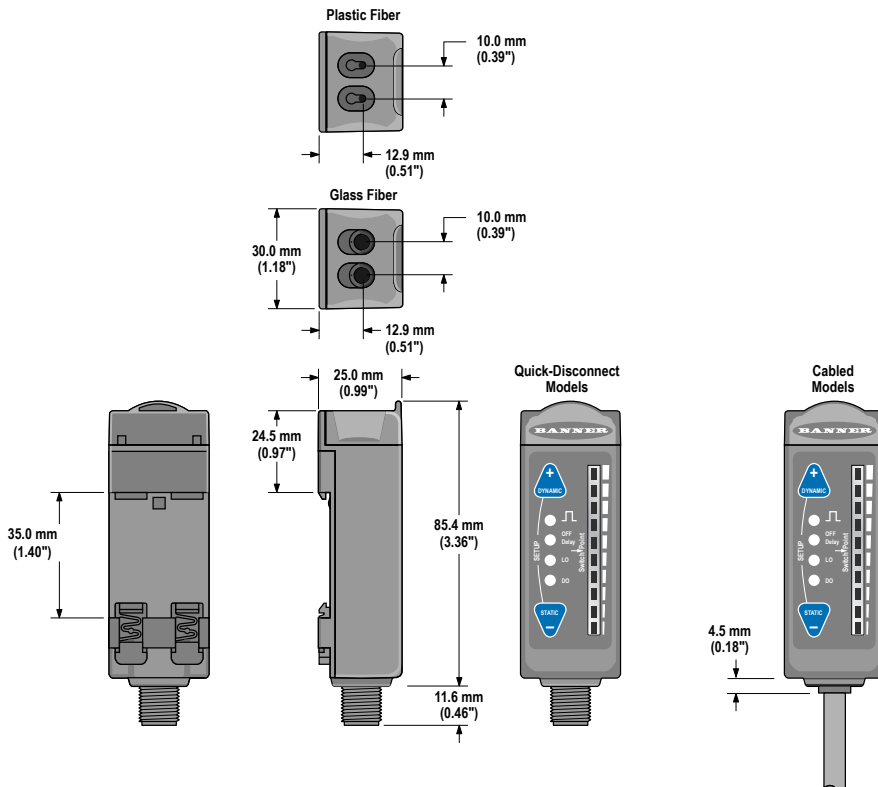

Brackets

Both brackets are included with the sensor.

**SMBR55FRA**

- Side-mounting bracket
- 19 ga stainless steel

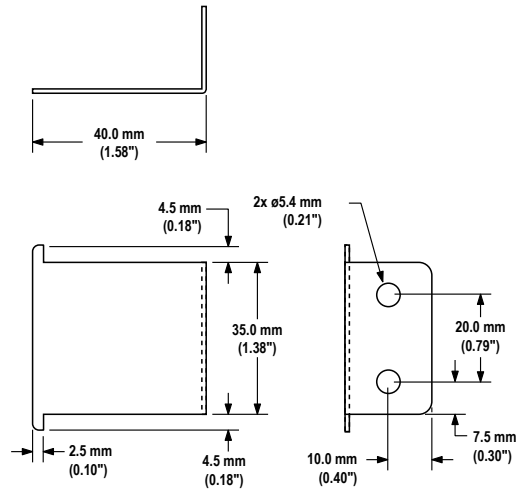

**SMBR55F01**

- Flat-mounting bracket
- Molded PBT polyester

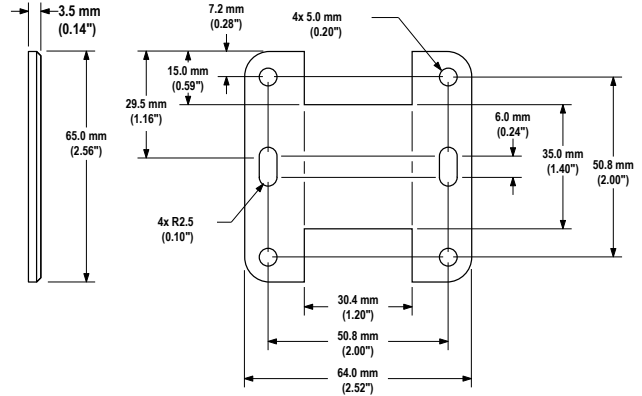

Accessories

Cordsets

5-Pin Threaded M12/Euro-Style Cordsets—Single Ended				
Model	Length	Style	Dimensions	Pinout (Female)
MQDC1-501.5	0.50 m (1.5 ft)	Straight		<p>1 = Brown 2 = White 3 = Blue 4 = Black 5 = Gray</p>
MQDC1-506	1.83 m (6 ft)			
MQDC1-515	4.57 m (15 ft)			
MQDC1-530	9.14 m (30 ft)	Right-Angle		
MQDC1-506RA	1.83 m (6 ft)			
MQDC1-515RA	4.57 m (15 ft)			
MQDC1-530RA	9.14 m (30 ft)			

Field-Wireable Connectors

M12 Euro-Style Field-Wireable Connectors				
Model	Gender	Style	Dimensions	Pinout
FIC-M12M5	Male	5-Pin Straight		

M12 Euro-Style Field-Wireable Connectors				
Model	Gender	Style	Dimensions	Pinout
FIC-M12F5	Female			
FIC-M12M5A	Male	5-Pin Right-Angle		
FIC-M12F5A	Female			

## Banner Engineering Corp. Limited Warranty

Banner Engineering Corp. warrants its products to be free from defects in material and workmanship for one year following the date of shipment. Banner Engineering Corp. will repair or replace, free of charge, any product of its manufacture which, at the time it is returned to the factory, is found to have been defective during the warranty period. This warranty does not cover damage or liability for misuse, abuse, or the improper application or installation of the Banner product.

**THIS LIMITED WARRANTY IS EXCLUSIVE AND IN LIEU OF ALL OTHER WARRANTIES WHETHER EXPRESS OR IMPLIED (INCLUDING, WITHOUT LIMITATION, ANY WARRANTY OF MERCHANTABILITY OR FITNESS FOR A PARTICULAR PURPOSE), AND WHETHER ARISING UNDER COURSE OF PERFORMANCE, COURSE OF DEALING OR TRADE USAGE.**

This Warranty is exclusive and limited to repair or, at the discretion of Banner Engineering Corp., replacement. **IN NO EVENT SHALL BANNER ENGINEERING CORP. BE LIABLE TO BUYER OR ANY OTHER PERSON OR ENTITY FOR ANY EXTRA COSTS, EXPENSES, LOSSES, LOSS OF PROFITS, OR ANY INCIDENTAL, CONSEQUENTIAL OR SPECIAL DAMAGES RESULTING FROM ANY PRODUCT DEFECT OR FROM THE USE OR INABILITY TO USE THE PRODUCT, WHETHER ARISING IN CONTRACT OR WARRANTY, STATUTE, TORT, STRICT LIABILITY, NEGLIGENCE, OR OTHERWISE.**

Banner Engineering Corp. reserves the right to change, modify or improve the design of the product without assuming any obligations or liabilities relating to any product previously manufactured by Banner Engineering Corp. Any misuse, abuse, or improper application or installation of this product or use of the product for personal protection applications when the product is identified as not intended for such purposes will void the product warranty. Any modifications to this product without prior express approval by Banner Engineering Corp will void the product warranties. All specifications published in this document are subject to change; Banner reserves the right to modify product specifications or update documentation at any time. Specifications and product information in English supersede that which is provided in any other language. For the most recent version of any documentation, refer to: [www.bannerengineering.com](http://www.bannerengineering.com).

For patent information, see [www.bannerengineering.com/patents](http://www.bannerengineering.com/patents).