

## Instruction Manual

*Self-Contained, DC-Operated Sensors*





- Featuring EZ-BEAM<sup>®</sup> technology for reliable sensing without the need for adjustments
- 30 mm plastic threaded barrel sensor in opposed, retroreflective, or fixed-field sensing modes
- Completely epoxy-encapsulated to provide superior durability, even in harsh sensing environments rated to IP69K
- Innovative dual-indicator system takes the guesswork out of sensor performance monitoring
- Advanced diagnostics to warn of marginal sensing conditions or output overload
- 10 V dc to 30 V dc; choose SPDT (complementary) NPN or PNP outputs (150 mA max. each)



### WARNING: Not To Be Used for Personnel Protection

**Never use this device as a sensing device for personnel protection. Doing so could lead to serious injury or death.** This device does not include the self-checking redundant circuitry necessary to allow its use in personnel safety applications. A sensor failure or malfunction can cause either an energized or de-energized sensor output condition.

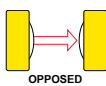
## Models

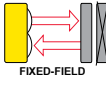
Sensing Mode	Model <sup>1</sup>	Output	Range	LED
 <p>OPPOSED</p>	S306E	—	60 m (196.8 ft)	Infrared, 950 nm
	S30SN6R	NPN		
	S30SP6R	PNP		
 <p>POLAR RETRO</p>	S30N6LP	NPN	6 m (19.7 ft)	Visible red, 680 nm
	S30SP6LP	PNP		
 <p>FIXED-FIELD</p>	S30SN6FF200	NPN	200 mm (7.9 in) cutoff	Infrared, 880 nm
	S30SP6FF200	PNP		
	S30SN6FF400	NPN	400 mm (15.7 in) cutoff	
	S30SP6FF400	PNP		
	S30SN6FF600	NPN	600 mm (23.6 in) cutoff	
	S30SP6FF600	PNP		

## Fixed-Field Mode Overview

S30 self-contained fixed-field sensors are small, powerful, infrared diffuse mode sensors with far-limit cutoff (a type of background suppression). Their high excess gain and fixed-field technology allow detection of objects of low reflectivity, while ignoring background surfaces.

The cutoff distance is fixed. Backgrounds and background objects must always be placed beyond the cutoff distance.

<sup>1</sup> Standard 2 m (6.5 ft) cable models are listed.

- 9 m (30 ft) cable: add suffix "W/30" (for example, S306E W/30).
- 4-pin Euro-style QD models: add suffix "Q" (for example, S306EQ). A model with a QD connector requires a mating cable.



## Fixed-Field Sensing – Theory of Operation

The S30FF compares the reflections of its emitted light beam (E) from an object back to the sensor's two differently aimed detectors, R1 and R2. See [Figure 1](#) on page 2. If the near detector's (R1) light signal is stronger than the far detector's (R2) light signal (see object A in the Figure below, closer than the cutoff distance), the sensor responds to the object. If the far detector's (R2) light signal is stronger than the near detector's (R1) light signal (see object B in the Figure below, beyond the cutoff distance), the sensor ignores the object.

The cutoff distance for model S30FF sensors is fixed at 200, 400, or 600 millimeters (7.9 in, 16.7 in, or 23.6 in). Objects lying beyond the cutoff distance are usually ignored, even if they are highly reflective. However, under certain conditions, it is possible to falsely detect a background object (see [Background Reflectivity and Placement](#) on page 2).

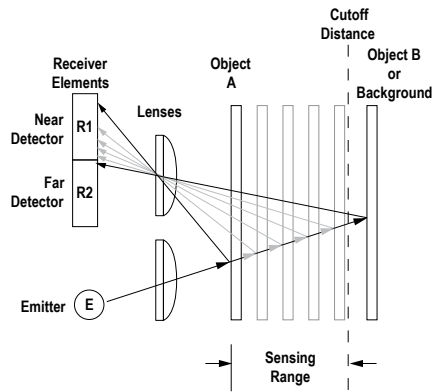

Object is sensed if amount of light at R1 is greater than the amount of light at R2  
 Figure 1. Fixed-Field Concept

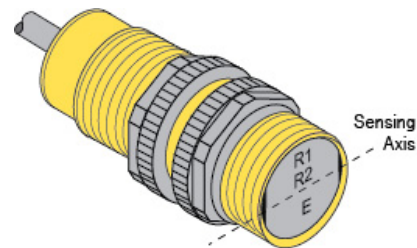

Figure 2. Fixed-Field Sensing Axis

In the drawings and information provided in this document, the letters E, R1, and R2 identify how the sensor's three optical elements (Emitter "E", Near Detector "R1", and Far Detector "R2") line up across the face of the sensor. The location of these elements defines the sensing axis, see [Figure 2](#) on page 2. The sensing axis becomes important in certain situations, such as those illustrated in [Figure 5](#) on page 3 and [Figure 6](#) on page 3.

## Device Setup

### Sensing Reliability

For highest sensitivity, position the target object for sensing at or near the point of maximum excess gain. Maximum excess gain for all models occurs at a lens-to-object distance of about 40 mm (1.5 in). Sensing at or near this distance makes the maximum use of each sensor's available sensing power. The background must be placed beyond the cutoff distance. Note that the reflectivity of the background surface also may affect the cutoff distance. Following these guidelines will improve sensing reliability.

### Background Reflectivity and Placement

Avoid mirror-like backgrounds that produce specular reflections. A false sensor response occurs if a background surface reflects the sensor's light more to the near detector (R1) than to the far detector (R2). The result is a false ON condition ([Figure 3](#) on page 3). To correct this problem, use a diffusely reflective (matte) background, or angle either the sensor or the background (in any plane) so the background does not reflect light back to the sensor ([Figure 4](#) on page 3). Position the background as far beyond the cutoff distance as possible.

An object beyond the cutoff distance, either stationary (and when positioned as shown in [Figure 5](#) on page 3), or moving past the face of the sensor in a direction perpendicular to the sensing axis, may cause unwanted triggering of the sensor if more light is reflected to the near detector than to the far detector. The problem is easily remedied by rotating the sensor 90° ([Figure 6](#) on page 3). The object then reflects the R1 and R2 fields equally, resulting in no false triggering. A better solution, if possible, may be to reposition the object or the sensor.

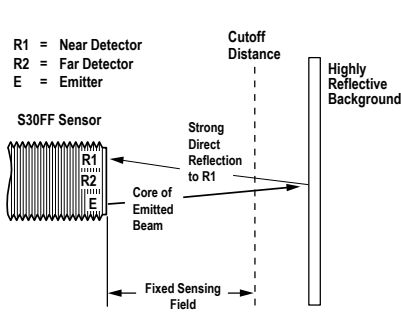

Figure 3. Reflective Background - Problem

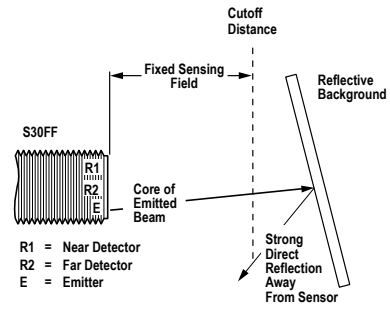
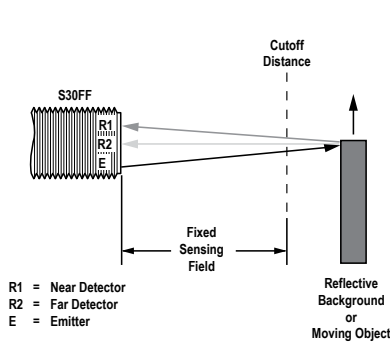
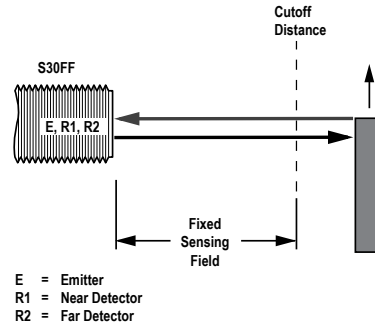

Figure 4. Reflective Background - Solution



A reflective background object in this position or moving across the sensor face in this axis and direction may cause false sensor response.

Figure 5. Object Beyond Cutoff - Problem



A reflective background object in this position or moving across the sensor face in this axis will be ignored.

Figure 6. Object Beyond Cutoff - Solution

## Color Sensitivity

The effects of object reflectivity on cutoff distance, though small, may be important for some applications. It is expected that at any given cutoff setting, the actual cutoff distance for lower reflectance targets is slightly shorter than for higher reflectance targets. This behavior is known as color sensitivity.

For example, an excess gain of 1 for an object that reflects 1/10 as much light as the 90% white card is represented by the horizontal graph line at excess gain = 10. An object of this reflectivity results in a far limit cutoff of approximately 190 mm (7.5 in) for the 200 mm (8 in) cutoff model, for example; 190 mm represents the cutoff for this sensor and target.

These excess gain curves were generated using a white test card of 90% reflectance. Objects with reflectivity of less than 90% reflect less light back to the sensor, and thus require proportionately more excess gain in order to be sensed with the same reliability as more reflective objects. When sensing an object of very low reflectivity, it may be especially important to sense it at or near the distance of maximum excess gain.

# Specifications

## Supply Voltage and Current

10 V dc to 30 V dc (10% max. ripple); supply current (exclusive of load current):

- Emitters, Non-Polarized, Retro:** 25 mA
- Receivers:** 20 mA
- Polarized Retroreflective:** 30 mA
- Fixed-Field:** 35 mA

## Supply Protection Circuitry

Protected against reverse polarity and transient voltages

## Output Configuration

SPDT solid-state dc switch; NPN (current sinking) or PNP (current sourcing) outputs, depending on model

**Light Operate:** N.O. output conducts when sensor sees its own (or the emitter's) modulated light

**Dark Operate:** N.C. output conducts when the sensor sees dark; the N.C. output may be wired as a normally open marginal signal alarm output, depending upon hookup to power supply

## Environmental Rating

Leakproof design rated NEMA 6P, DIN 40050 (IEC IP69K)

## Construction

PBT polyester housing; polycarbonate (opposed-mode) or acrylic lens

## Required Overcurrent Protection



**WARNING:** Electrical connections must be made by qualified personnel in accordance with local and national electrical codes and regulations.

Overcurrent protection is required to be provided by end product application per the supplied table. Overcurrent protection may be provided with external fusing or via Current Limiting, Class 2 Power Supply. Supply wiring leads < 24 AWG shall not be spliced. For additional product support, go to <http://www.bannerengineering.com>.

Supply Wiring (AWG)	Required Overcurrent Protection (Amps)
20	5.0
22	3.0
24	2.0
26	1.0
28	0.8
30	0.5

## Output Rating

150 mA maximum (each) in standard hookup. When wired for alarm output, the total load may not exceed 150 mA.

- OFF-state leakage current:** < 1  $\mu$ A at 30 V dc
- ON-state saturation voltage:** < 1V at 10 mA dc; < 1.5 V at 150 mA dc

## Output Protection Circuitry

Protected against false pulse on power-up and continuous overload or short circuit of outputs

## Output Response Time

- Opposed mode:** 3 ms ON, 1.5 ms OFF
- Retro, Fixed-Field and Diffuse:** 3 ms ON and OFF



**Note:** 100 ms delay on power-up; outputs do not conduct during this time.

## Repeatability

- Opposed mode:** 375  $\mu$ s
  - Retro, Fixed-Field and Diffuse:** 750  $\mu$ s
- Repeatability and response are independent of signal strength.

## Indicators

- Two LEDs (Green and Yellow)
- Green ON steady:** power to sensor is ON
- Green flashing:** output is overloaded
- Yellow ON steady:** N.O. output is conducting
- Yellow flashing:** excess gain marginal (1 to 1.5 times) in light condition

## Connections

2 m (6.5 ft) or 9 m (29.5 ft) attached cable or 4-pin Euro-style quick-disconnect fitting

## Operating Conditions

- Temperature:** -40 °C to +70 °C (-40 °F to +158 °F)
- Humidity:** 90% at +50 °C maximum relative humidity (non-condensing)

## Vibration and Mechanical Shock

All models meet Mil. Std. 202F requirements. Method 201A (Vibration; frequency 10 Hz to 60 Hz, max., double amplitude 0.06 inch acceleration 10G). Method 213B conditions H&I. (Shock: 75G with unit operating; 100G for non-operation)

## Certifications

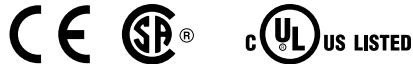

# Performance Curves

Table 1: Opposed Mode Sensors

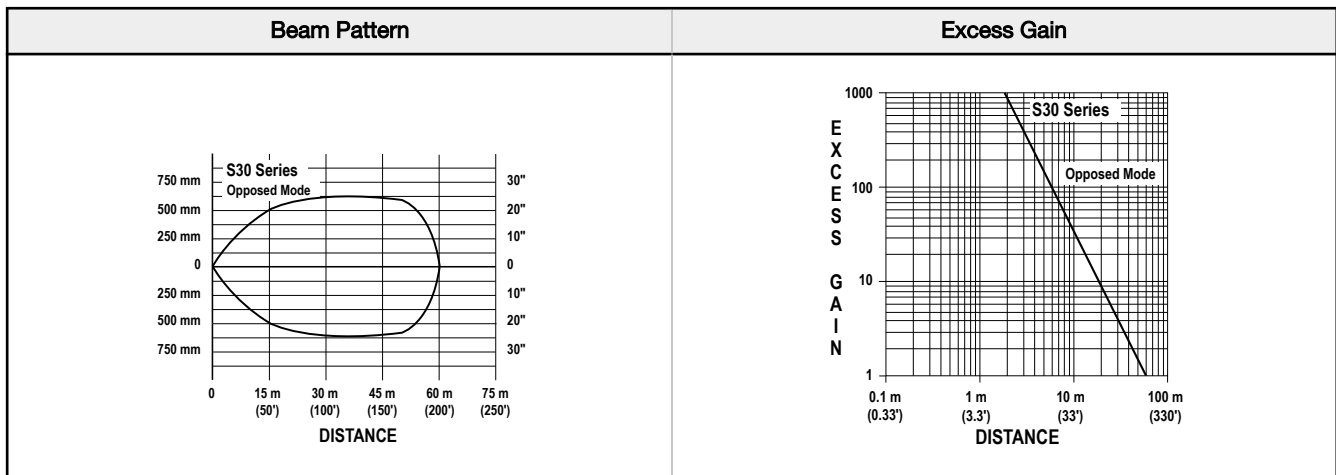

Table 2: Polarized Retro Mode Sensors<sup>2</sup>

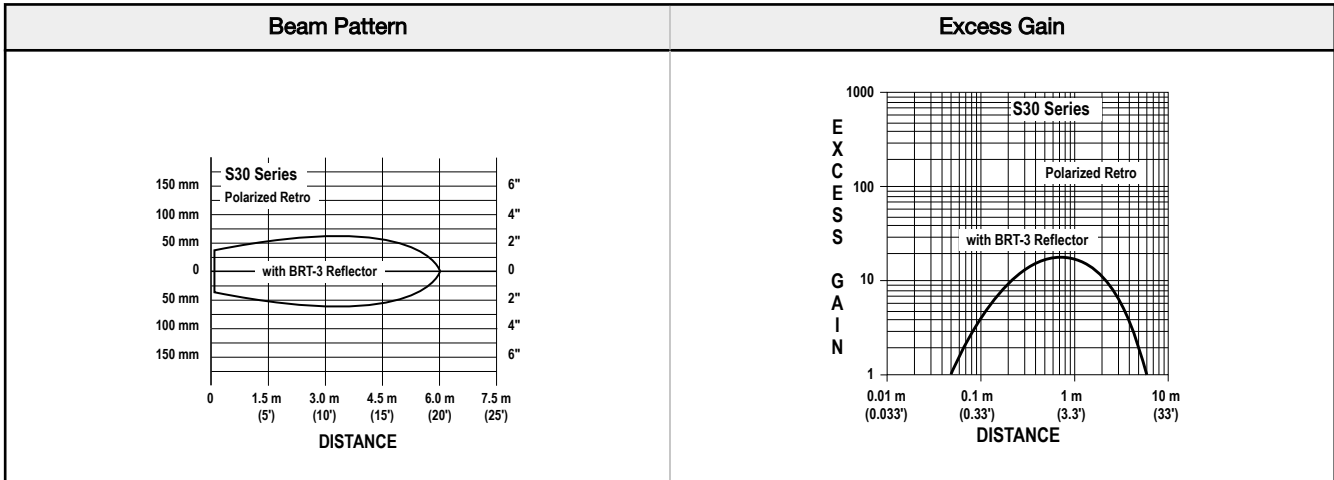
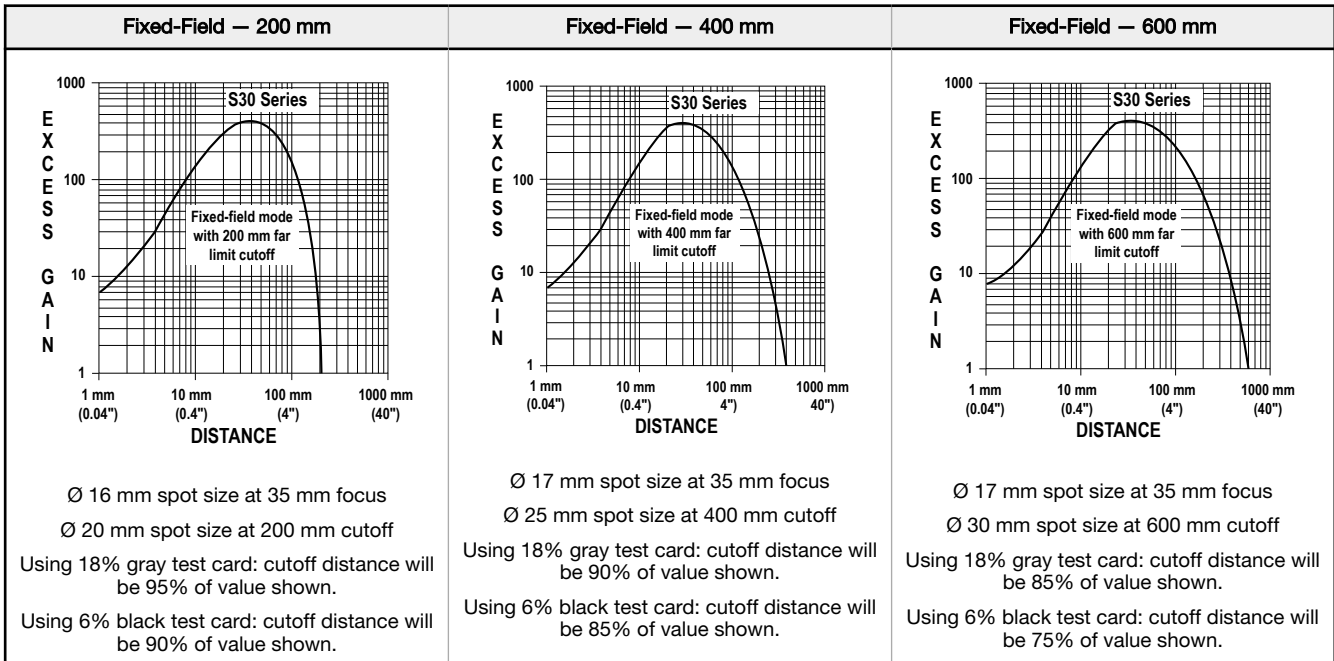

Table 3: Fixed-Field Mode Sensors Excess Gain<sup>3</sup>



<sup>2</sup> Performance based on use of a model BRT-3 retroreflector (3-inch diameter). Actual sensing range may be more or less than specified, depending on the efficiency and reflective area of the retroreflector used.

<sup>3</sup> Performance based on use of a 90% reflectance white test card. Focus and spot sizes are typical.

Dimensions

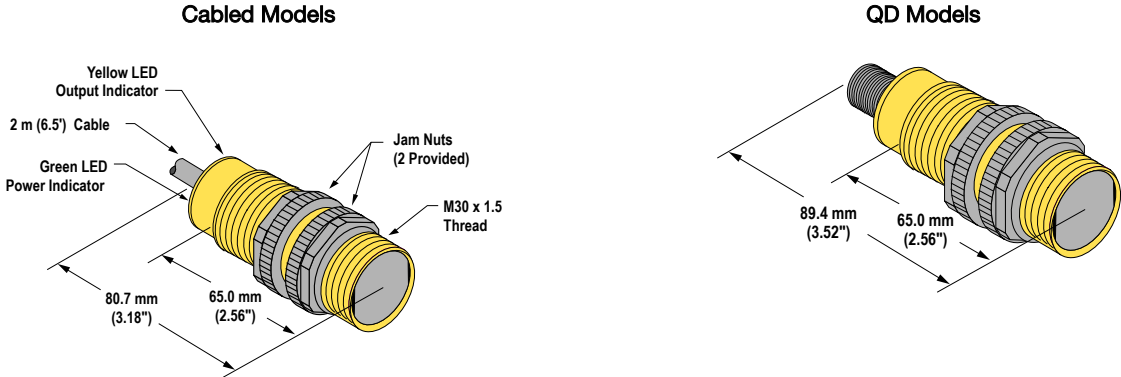

Wiring Diagrams

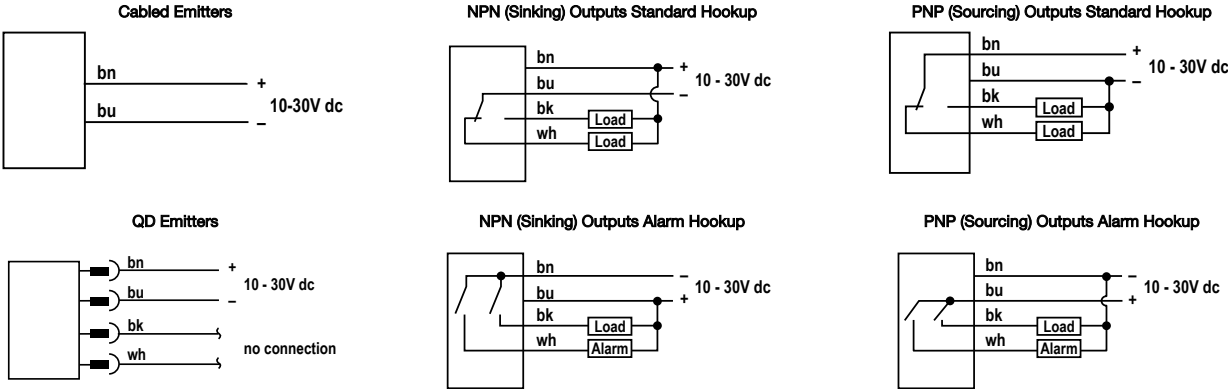

**Note:** Cabled hookups are shown. QD hookups are functionally identical.

Cables

All measurements are listed in millimeters (inches), unless noted otherwise.

4-Pin Threaded M12/Euro-Style Cordsets				
Model	Length	Style	Dimensions	Pinout (Female)
MQDC-406	1.83 m (6 ft)	Straight		<p>1 = Brown 2 = White 3 = Blue 4 = Black</p>
MQDC-415	4.57 m (15 ft)			
MQDC-430	9.14 m (30 ft)			
MQDC-450	15.2 m (50 ft)			
MQDC-406RA	1.83 m (6 ft)	Right-Angle		
MQDC-415RA	4.57 m (15 ft)			
MQDC-430RA	9.14 m (30 ft)			
MQDC-450RA	15.2 m (50 ft)			

## Banner Engineering Corp. Limited Warranty

---

Banner Engineering Corp. warrants its products to be free from defects in material and workmanship for one year following the date of shipment. Banner Engineering Corp. will repair or replace, free of charge, any product of its manufacture which, at the time it is returned to the factory, is found to have been defective during the warranty period. This warranty does not cover damage or liability for misuse, abuse, or the improper application or installation of the Banner product.

**THIS LIMITED WARRANTY IS EXCLUSIVE AND IN LIEU OF ALL OTHER WARRANTIES WHETHER EXPRESS OR IMPLIED (INCLUDING, WITHOUT LIMITATION, ANY WARRANTY OF MERCHANTABILITY OR FITNESS FOR A PARTICULAR PURPOSE), AND WHETHER ARISING UNDER COURSE OF PERFORMANCE, COURSE OF DEALING OR TRADE USAGE.**

This Warranty is exclusive and limited to repair or, at the discretion of Banner Engineering Corp., replacement. **IN NO EVENT SHALL BANNER ENGINEERING CORP. BE LIABLE TO BUYER OR ANY OTHER PERSON OR ENTITY FOR ANY EXTRA COSTS, EXPENSES, LOSSES, LOSS OF PROFITS, OR ANY INCIDENTAL, CONSEQUENTIAL OR SPECIAL DAMAGES RESULTING FROM ANY PRODUCT DEFECT OR FROM THE USE OR INABILITY TO USE THE PRODUCT, WHETHER ARISING IN CONTRACT OR WARRANTY, STATUTE, TORT, STRICT LIABILITY, NEGLIGENCE, OR OTHERWISE.**

Banner Engineering Corp. reserves the right to change, modify or improve the design of the product without assuming any obligations or liabilities relating to any product previously manufactured by Banner Engineering Corp.



more sensors, more solutions