

Instruction Manual

Self-Contained, DC-Operated Sensors



- Featuring EZ-BEAM® technology, specially designed optics and electronics provide reliable sensing without adjustments
- “T” style PBT polyester housing with 30 mm threaded lens in opposed, retroreflective, or fixed-field modes
- Completely epoxy-encapsulated providing superior durability, even in harsh sensing environments, rated to DIN IP69K
- Innovative dual-indicator system takes the guesswork out of sensor performance monitoring
- Advanced diagnostics warn of marginal sensing conditions or output overload
- 10 V dc to 30 V dc; choose SPDT (complementary) NPN or PNP outputs (150 mA maximum each)



WARNING: Not To Be Used for Personnel Protection

Never use this device as a sensing device for personnel protection. Doing so could lead to serious injury or death. This device does not include the self-checking redundant circuitry necessary to allow its use in personnel safety applications. A sensor failure or malfunction can cause either an energized or de-energized sensor output condition.

Models

Sensing Mode	Model ¹	Output	Range	LED
<p>OPPOSED</p>	T306E	-	60 m (196.8 ft)	Infrared, 950 nm
	T30SN6R	NPN		
	T30SP6R	PNP		
<p>POLAR RETRO</p>	T30SN6LP	NPN	6 m (19.7 ft)	Visible red, 680 nm
	T30SP6LP	PNP		
<p>FIXED-FIELD</p>	T30SN6FF200	NPN	200 mm (7.9 in) cutoff	Infrared, 880 nm
	T30SP6FF200	PNP		
	T30SN6FF400	NPN	400 mm (15.7 in) cutoff	
	T30SP6FF400	PNP		
	T30SN6FF600	NPN	600 mm (23.6 in) cutoff	
	T30SP6FF600	PNP		

Fixed-Field Mode Overview

T30 self-contained fixed-field sensors are small, powerful, infrared diffuse mode sensors with far-limit cutoff (a type of background suppression). Their high excess gain and fixed-field technology allow detection of objects of low reflectivity, while ignoring background surfaces.

The cutoff distance is fixed. Backgrounds and background objects must always be placed beyond the cutoff distance.

Fixed-Field Sensing – Theory of Operation

The T30 Fixed-Field sensor compares the reflections of its emitted light beam (E) from an object back to the sensor's two differently aimed detectors, R1 and R2. See [Figure 1](#) on page 2. If the near detector's (R1) light signal is stronger than the far detector's (R2) light signal (see object A in the Figure below, closer than the cutoff distance), the sensor responds to the object. If the far detector's (R2) light signal is stronger than the near detector's (R1) light signal (see object B in the Figure below, beyond the cutoff distance), the sensor ignores the object.

¹ Integral 2 m (6.5 ft) unterminated cable models are listed.

- To order the 9 m (30 ft) PVC cable model, add the suffix "W/30" to the cabled model number. For example, T306E W/30.
- To order the 4-pin M12/Euro-style integral quick disconnect model, add the suffix "Q" to the model number. For example, T306EQ.
- Models with a quick disconnect require a mating cordset.



The cutoff distance for the T30 is fixed at 200, 400, or 600 millimeters (7.9 inch, 16.7 inch, or 23.6 inch). Objects lying beyond the cutoff distance are usually ignored, even if they are highly reflective. However, under certain conditions, it is possible to falsely detect a background object (see [Background Reflectivity and Placement](#) on page 2).

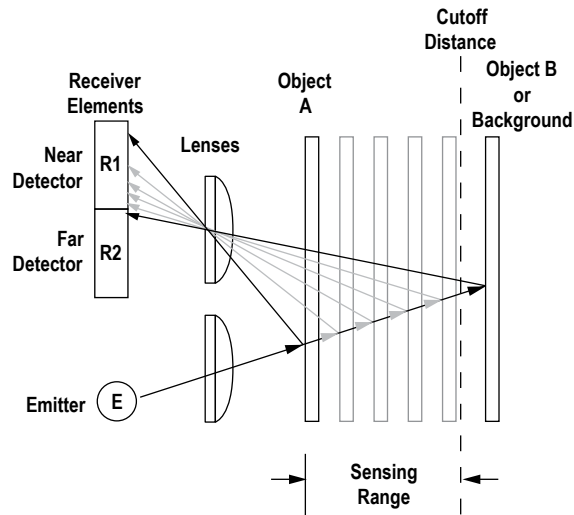

Object is sensed if amount of light at R1 is greater than the amount of light at R2

Figure 1. Fixed-Field Concept

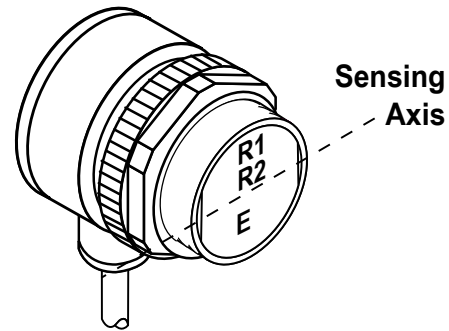

Figure 2. Fixed-Field Sensing Axis

In the drawings and information provided in this document, the letters E, R1, and R2 identify how the sensor's three optical elements (Emitter "E", Near Detector "R1", and Far Detector "R2") line up across the face of the sensor. The location of these elements defines the sensing axis, see [Figure 2](#) on page 2. The sensing axis becomes important in certain situations, such as those illustrated in [Figure 5](#) on page 3 and [Figure 6](#) on page 3.

Sensor Setup

Sensing Reliability

For highest sensitivity, position the target for sensing at or near the point of maximum excess gain. Maximum excess gain for all models occurs at a lens-to-object distance of about 40 mm (1.5 in). Sensing at or near this distance makes the maximum use of each sensor's available sensing power. The background must be placed beyond the cutoff distance. Note that the reflectivity of the background surface also may affect the cutoff distance. Following these guidelines improves sensing reliability.

Background Reflectivity and Placement

Avoid mirror-like backgrounds that produce specular reflections. A false sensor response occurs if a background surface reflects the sensor's light more to the near detector (R1) than to the far detector (R2). The result is a false ON condition ([Figure 3](#) on page 3). Correct this problem by using a diffusely reflective (matte) background, or angling either the sensor or the background (in any plane) so the background does not reflect light back to the sensor ([Figure 4](#) on page 3). Position the background as far beyond the cutoff distance as possible.

An object beyond the cutoff distance, either stationary (and when positioned as shown in [Figure 5](#) on page 3), or moving past the face of the sensor in a direction perpendicular to the sensing axis, may cause unwanted triggering of the sensor if more light is reflected to the near detector than to the far detector. Correct the problem by rotating the sensor 90° ([Figure 6](#) on page 3). The object then reflects the R1 and R2 fields equally, resulting in no false triggering. A better solution, if possible, may be to reposition the object or the sensor.

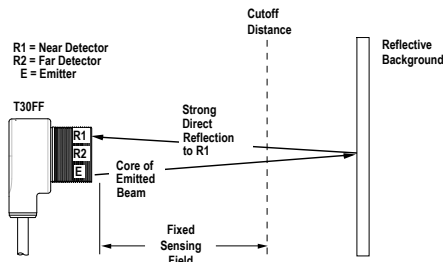

Figure 3. Reflective Background - Problem

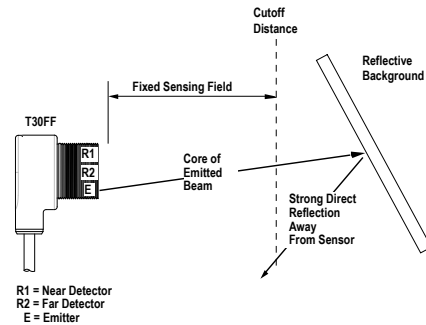
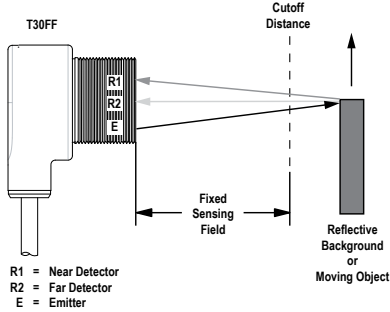
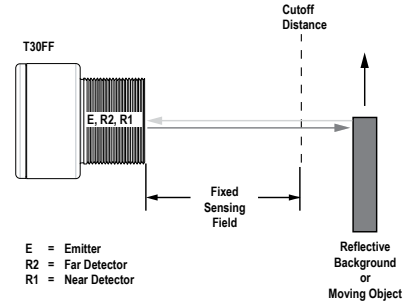

Figure 4. Reflective Background - Solution



A reflective background object in this position or moving across the sensor face in this axis and direction may cause a false sensor response.

Figure 5. Object Beyond Cutoff - Problem



A reflective background object in this position or moving across the sensor face in this axis is ignored.

Figure 6. Object Beyond Cutoff - Solution

Color Sensitivity

The effects of object reflectivity on cutoff distance, though small, may be important for some applications. It is expected that at any given cutoff setting, the actual cutoff distance for lower reflectance targets is slightly shorter than for higher reflectance targets. This behavior is known as color sensitivity.

For example, an excess gain of 1 for an object that reflects 1/10 as much light as the 90% white card is represented by the horizontal graph line at excess gain = 10. An object of this reflectivity results in a far limit cutoff of approximately 190 mm (7.5 inch) for the 200 mm (8 inch) cutoff model, for example; and 190 mm represents the cutoff for this sensor and target.

These excess gain curves were generated using a white test card of 90% reflectance. Objects with reflectivity of less than 90% reflect less light back to the sensor, and thus require proportionately more excess gain in order to be sensed with the same reliability as more reflective objects. When sensing an object of very low reflectivity, it may be especially important to sense it at or near the distance of maximum excess gain.

Wiring Diagrams

Cabled Emitters

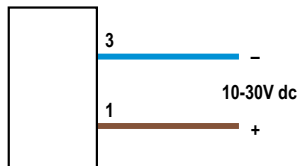

NPN Standard

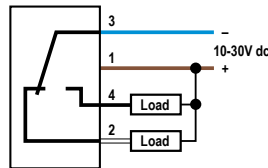

PNP Standard

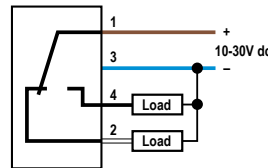

Key:

- Wire 1 = Brown
- Wire 2 = White
- Wire 3 = Blue
- Wire 4 = Black

Quick Disconnect Emitters

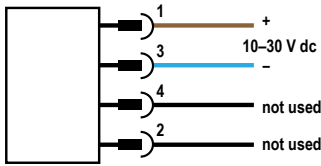

NPN Alarm

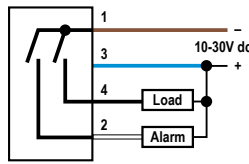

PNP Alarm

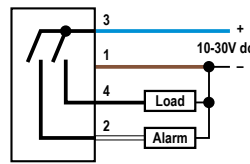

Specifications

Supply Voltage and Current

10 V dc to 30 V dc (10% maximum ripple)
Supply current (exclusive of load current):

- Emitters, Non-Polarized, Retro:** 25 mA
- Receivers:** 20 mA
- Polarized Retroreflective:** 30 mA
- Fixed-Field:** 35 mA

Output Configuration

SPDT solid-state dc switch; NPN or PNP outputs, depending on model
Light Operate: N.O. output conducts when sensor sees its own (or the emitter's) modulated light
Dark Operate: N.C. output conducts when the sensor sees dark; the N.C. output may be wired as a normally open marginal signal alarm output, depending on wiring to power supply

Output Rating

150 mA maximum each
When wired for alarm output, the total load may not exceed 150 mA
OFF-state leakage current: < 1 µA at 30 V dc
ON-state saturation voltage: < 1 V at 10 mA dc; < 1.5 V at 150 mA dc

Required Overcurrent Protection



WARNING: Electrical connections must be made by qualified personnel in accordance with local and national electrical codes and regulations.

Overcurrent protection is required to be provided by end product application per the supplied table.
Overcurrent protection may be provided with external fusing or via Current Limiting, Class 2 Power Supply.
Supply wiring leads < 24 AWG shall not be spliced.
For additional product support, go to www.bannerengineering.com.

Supply Wiring (AWG)	Required Overcurrent Protection (Amps)
20	5.0
22	3.0
24	2.0
26	1.0
28	0.8
30	0.5

Supply Protection Circuitry

Protected against reverse polarity and transient voltages

Output Protection Circuitry

Protected against output short-circuit, continuous overload, and false pulse on power-up

Output Response Time

Opposed mode: 3 ms ON, 1.5 ms OFF
Retro, Fixed-Field and Diffuse: 3 ms ON and OFF



Note: 100 ms delay on power-up; outputs do not conduct during this time

Repeatability

Opposed mode: 375 µs
Retro, Fixed-Field and Diffuse: 750 µs
Repeatability and response are independent of signal strength

Indicators

Two LEDs (Green and Amber)
Green ON steady: power to sensor is ON
Green flashing: output is overloaded
Amber ON steady: N.O. output is conducting
Amber flashing: excess gain marginal (1 to 1.5 times) in light condition

Construction

Housing: PBT polyester
Lens: Polycarbonate (opposed-mode) or acrylic

Environmental Rating

Leakproof design rated NEMA 6P, DIN IP69K

Connections

2 m (6.5 ft) or 9 m (30 ft) integral PVC cable or Integral 4-pin M12/Euro-style quick disconnect

Operating Conditions

Temperature: -40 °C to +70 °C (-40 °F to +158 °F)
Humidity: 90% at +50 °C maximum relative humidity (non-condensing)

Vibration and Mechanical Shock

All models meet MIL-STD-202F, Method 201A (Vibration: 10 Hz to 60 Hz maximum, 0.06 inch (1.52 mm) double amplitude, 10G acceleration) requirements. Method 213B conditions H&I. (Shock: 75G with unit operating; 100G for non-operation)

Certifications



Dimensions

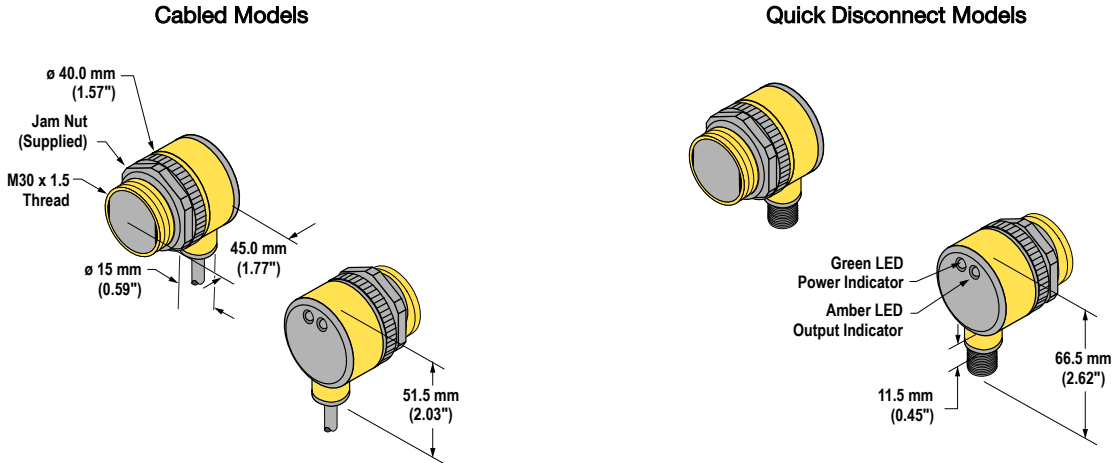

Performance Curves

Table 1: Opposed Mode Sensors

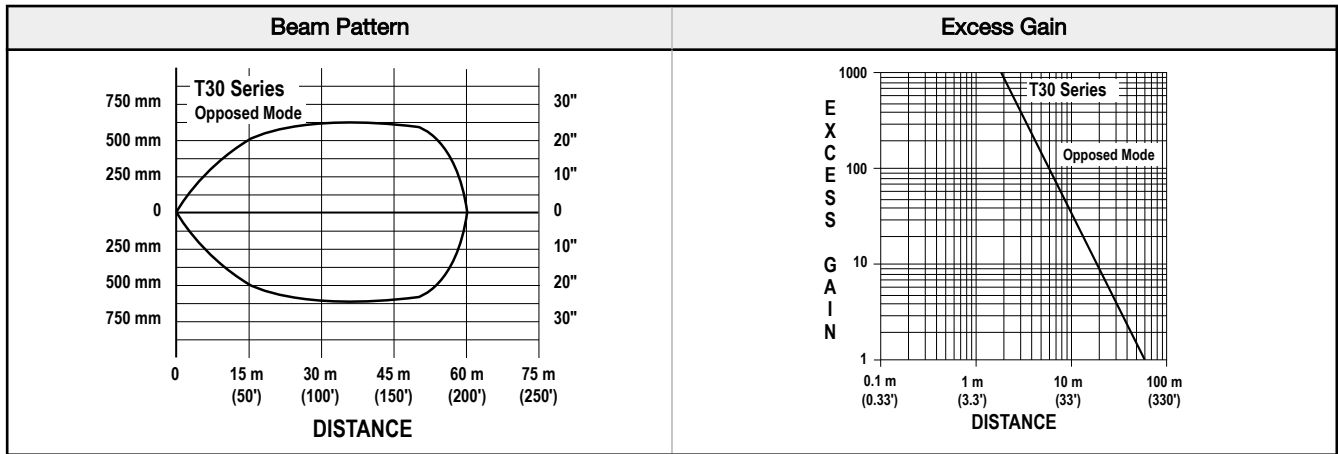
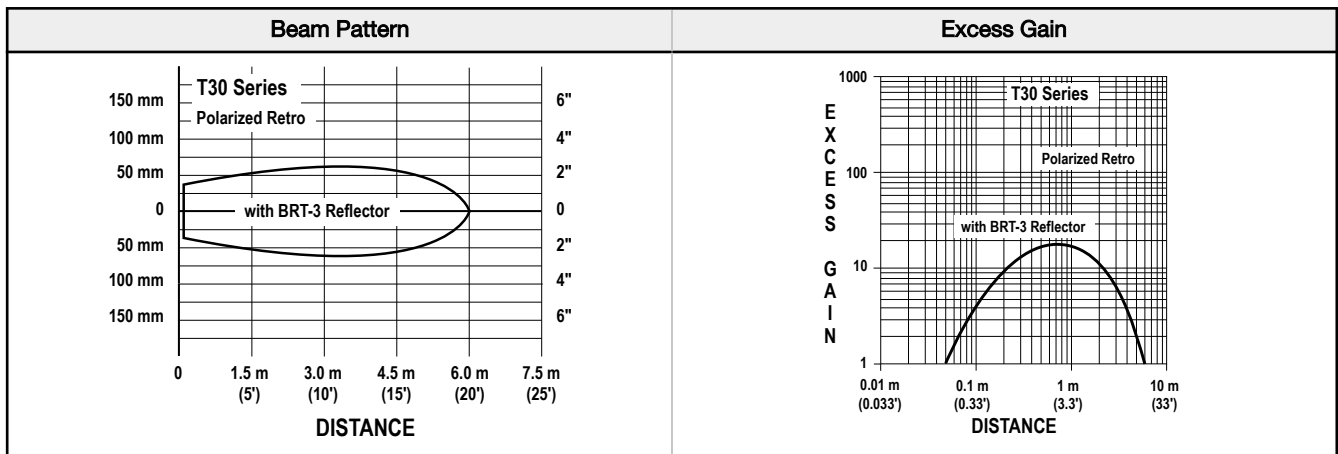

Table 2: Polarized Retro Mode Sensors²



² Performance based on use of a model BRT-3 retroreflector (3-inch diameter). Actual sensing range may be more or less than specified, depending on the efficiency and reflective area of the retroreflector used.

Table 3: Fixed-Field Mode Sensor Excess Gain³

Fixed-Field – 200 mm	Fixed-Field – 400 mm	Fixed-Field – 600 mm
<p>Ø 16 mm spot size at 35 mm focus Ø 20 mm spot size at 200 mm cutoff Using 18% gray test card: cutoff distance will be 95% of value shown. Using 6% black test card: cutoff distance will be 90% of value shown.</p>	<p>Ø 17 mm spot size at 35 mm focus Ø 25 mm spot size at 400 mm cutoff Using 18% gray test card: cutoff distance will be 90% of value shown. Using 6% black test card: cutoff distance will be 85% of value shown.</p>	<p>Ø 17 mm spot size at 35 mm focus Ø 30 mm spot size at 600 mm cutoff Using 18% gray test card: cutoff distance will be 85% of value shown. Using 6% black test card: cutoff distance will be 75% of value shown.</p>

Accessories

Cordsets

4-Pin Threaded M12/Euro-Style Cordsets				
Model	Length	Style	Dimensions	Pinout (Female)
MQDC-406	1.83 m (6 ft)	Straight		<p>1 = Brown 2 = White 3 = Blue 4 = Black</p>
MQDC-415	4.57 m (15 ft)			
MQDC-430	9.14 m (30 ft)			
MQDC-450	15.2 m (50 ft)	Right-Angle		
MQDC-406RA	1.83 m (6 ft)			
MQDC-415RA	4.57 m (15 ft)			
MQDC-430RA	9.14 m (30 ft)			
MQDC-450RA	15.2 m (50 ft)			

³ Performance based on use of a 90% reflectance white test card. Focus and spot sizes are typical.

Banner Engineering Corp. Limited Warranty

Banner Engineering Corp. warrants its products to be free from defects in material and workmanship for one year following the date of shipment. Banner Engineering Corp. will repair or replace, free of charge, any product of its manufacture which, at the time it is returned to the factory, is found to have been defective during the warranty period. This warranty does not cover damage or liability for misuse, abuse, or the improper application or installation of the Banner product.

THIS LIMITED WARRANTY IS EXCLUSIVE AND IN LIEU OF ALL OTHER WARRANTIES WHETHER EXPRESS OR IMPLIED (INCLUDING, WITHOUT LIMITATION, ANY WARRANTY OF MERCHANTABILITY OR FITNESS FOR A PARTICULAR PURPOSE), AND WHETHER ARISING UNDER COURSE OF PERFORMANCE, COURSE OF DEALING OR TRADE USAGE.

This Warranty is exclusive and limited to repair or, at the discretion of Banner Engineering Corp., replacement. **IN NO EVENT SHALL BANNER ENGINEERING CORP. BE LIABLE TO BUYER OR ANY OTHER PERSON OR ENTITY FOR ANY EXTRA COSTS, EXPENSES, LOSSES, LOSS OF PROFITS, OR ANY INCIDENTAL, CONSEQUENTIAL OR SPECIAL DAMAGES RESULTING FROM ANY PRODUCT DEFECT OR FROM THE USE OR INABILITY TO USE THE PRODUCT, WHETHER ARISING IN CONTRACT OR WARRANTY, STATUTE, TORT, STRICT LIABILITY, NEGLIGENCE, OR OTHERWISE.**

Banner Engineering Corp. reserves the right to change, modify or improve the design of the product without assuming any obligations or liabilities relating to any product previously manufactured by Banner Engineering Corp. Any misuse, abuse, or improper application or installation of this product or use of the product for personal protection applications when the product is identified as not intended for such purposes will void the product warranty. Any modifications to this product without prior express approval by Banner Engineering Corp will void the product warranties. All specifications published in this document are subject to change; Banner reserves the right to modify product specifications or update documentation at any time. Specifications and product information in English supersede that which is provided in any other language. For the most recent version of any documentation, refer to: www.bannerengineering.com.

For patent information, see www.bannerengineering.com/patents.