

Datasheet

Low Profile Miniature Self-Contained Sensors

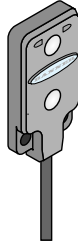

- Extremely low profile self-contained miniature
- Visible red sensing beam
- 10 v dc to 30 v dc supply voltage
- NPN or PNP output, depending on model
- 15 mm or 30 mm convergent point, depending on model
- Available in dark- or light- operate models



WARNING: Not To Be Used for Personnel Protection

Never use this device as a sensing device for personnel protection. Doing so could lead to serious injury or death. This device does not include the self-checking redundant circuitry necessary to allow its use in personnel safety applications. A sensor failure or malfunction can cause either an energized or de-energized sensor output condition.

Models

Model ¹	Output Type	Range	Supply Voltage
VS2AN5CV15	NPN Light Operate	15 mm (0.6 inch) ±5 mm	10 V dc to 30 V dc
VS2RN5CV15	NPN Dark Operate		
VS2AP5CV15	PNP Light Operate		
VS2RP5CV15	PNP Dark Operate		
VS2AN5CV30	NPN Light Operate	30 mm (1.2 inch) ±10 mm	
VS2RN5CV30	NPN Dark Operate		
VS2AP5CV30	PNP Light Operate		
VS2RP5CV30	PNP Dark Operate		

Overview

VS2 Series miniature self-contained sensors are designed for precision sensing in small areas previously accessible only to remote or fiber optic models. Typical applications include mounting inside vibrating feeders and electronic component handling equipment.

¹ Integral 2 m (6.5 ft) unterminated cable models are listed.

- To order the 3-pin M8/Pico-style integral quick disconnect model, add the suffix "Q" to the model number. For example, VS2AN5CV15Q.
- Models with a quick disconnect require a mating cordset.



Wiring Diagrams



Specifications

Supply Voltage and Current

10 V dc to 30 V dc (10% max. ripple) at less than 25 mA (exclusive of load)

Supply Protection Circuitry

Protected against reverse polarity and transient voltages

Output Configuration

SPST solid-state switch
Choose NPN or PNP models
Choose light operate or dark operate models

Output Rating

50 mA maximum
Off-state leakage current: < 1 microamp at 24 V dc
On-state saturation voltage: < 0.25 V at 10 mA dc; < 0.5 V at 50 mA dc

Output Protection Circuitry

Protected against output short-circuit, continuous overload, and false pulse on power-up
Overload trip point \geq 100 mA

Output Response Time

1 millisecond ON and OFF



Note: 150 millisecond delay maximum on power-up: output does not conduct during this time

Repeatability

160 microseconds

Indicators

Two LEDs: Green and Amber
Green ON = power to sensor is ON
Green flashing = output overload
Amber ON = light is sensed

Construction

Black ABS housing with acrylic lens

Connections

2 m (6.5 in) PVC integral cable: three #28 ga stranded conductors with PE insulation; 150 mm (6 in) PVC cable with a 3-pin M8/Pico-style male quick disconnect (QD). Quick disconnect cables are ordered separately.

Environmental Rating

IEC IP67; NEMA 6

Operating Conditions

-20 °C to +55 °C (-4 °F to +131 °F)
80% at +50 °C maximum relative humidity (non-condensing)

Vibration and Mechanical Shock

Vibration: All models meet IEC 60068-2-6, IEC 60947-5-2, UL491 Section 40, MIL-STD-202F Method 201A; 10 to 60 Hz, 0.5 mm peak to peak
Shock: All models meet IEC 60068-2-27, IEC 60947-5-2; 30g peak acceleration, 11 millisecond pulse duration, half-sine wave pulse shape

Application Notes

M2 stainless steel mounting hardware included. Optional mounting brackets are available.

Certifications



Dimensions

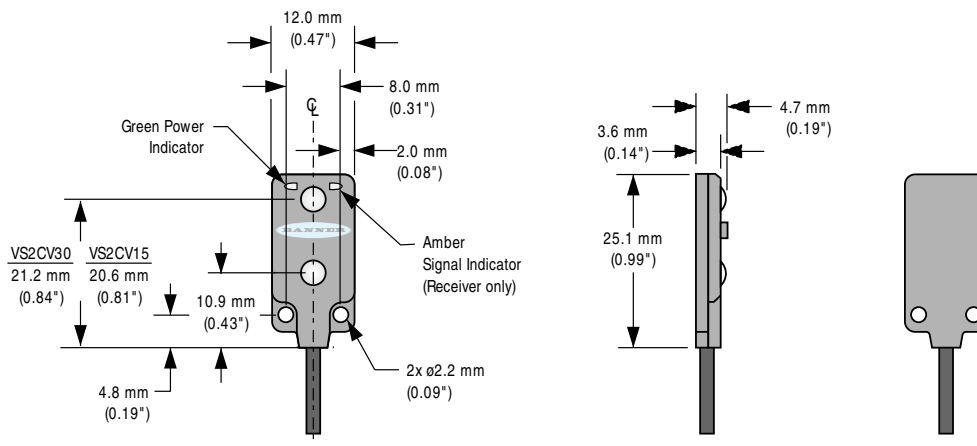

Performance Curves

Excess Gain Curve — 15 mm Models

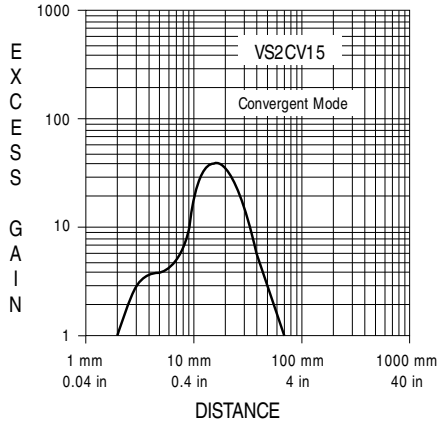

Beam Pattern — 15 mm Models

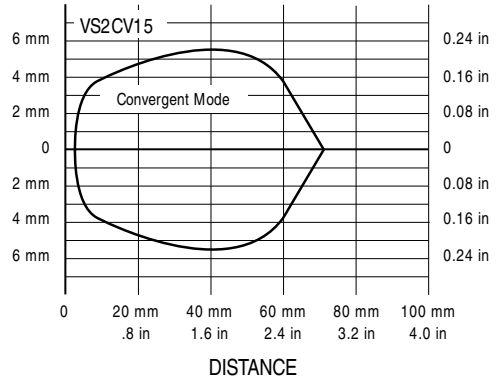

Excess Gain Curve — 30 mm Models

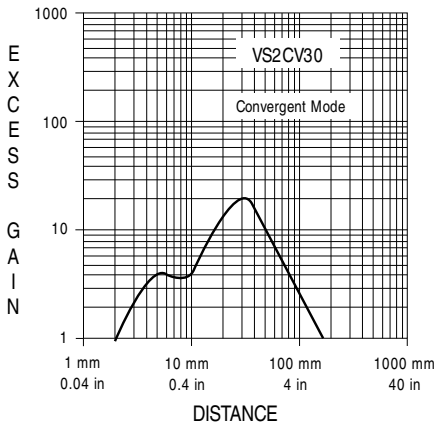

Beam Pattern — 30 mm Models

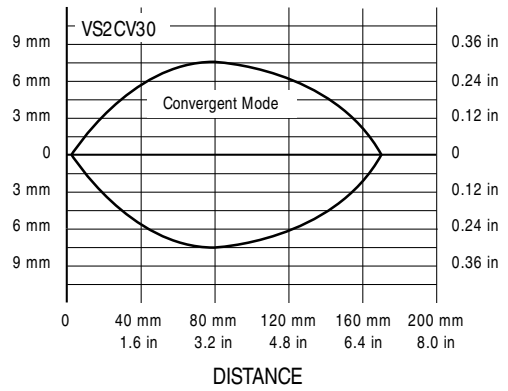

Accessories

Quick-Disconnect Cables

3-Pin Threaded M8/ Pico-Style Cordsets				
Model	Length	Style	Dimensions	Pinout (Female)
PKG3M-2	2 m (6.56 ft)	Straight		<p>1 = Brown 3 = Blue 4 = Black</p>
PKG3M-5	5 m (16.40 ft)			
PKG3M-7	7 m (22.97 ft)			
PKG3M-9	9 m (29.53 ft)			
PKG3M-10	10 m (32.81 ft)			

Brackets

SM BVS2RA

- Right-angle bracket
- Stainless steel

Hole center spacing: A = 80.0

Hole size: A = 3.2 x 6.0

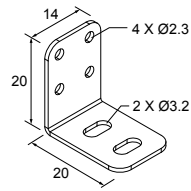

Banner Engineering Corp. Limited Warranty

Banner Engineering Corp. warrants its products to be free from defects in material and workmanship for one year following the date of shipment. Banner Engineering Corp. will repair or replace, free of charge, any product of its manufacture which, at the time it is returned to the factory, is found to have been defective during the warranty period. This warranty does not cover damage or liability for misuse, abuse, or the improper application or installation of the Banner product.

THIS LIMITED WARRANTY IS EXCLUSIVE AND IN LIEU OF ALL OTHER WARRANTIES WHETHER EXPRESS OR IMPLIED (INCLUDING, WITHOUT LIMITATION, ANY WARRANTY OF MERCHANTABILITY OR FITNESS FOR A PARTICULAR PURPOSE), AND WHETHER ARISING UNDER COURSE OF PERFORMANCE, COURSE OF DEALING OR TRADE USAGE.

This Warranty is exclusive and limited to repair or, at the discretion of Banner Engineering Corp., replacement. **IN NO EVENT SHALL BANNER ENGINEERING CORP. BE LIABLE TO BUYER OR ANY OTHER PERSON OR ENTITY FOR ANY EXTRA COSTS, EXPENSES, LOSSES, LOSS OF PROFITS, OR ANY INCIDENTAL, CONSEQUENTIAL OR SPECIAL DAMAGES RESULTING FROM ANY PRODUCT DEFECT OR FROM THE USE OR INABILITY TO USE THE PRODUCT, WHETHER ARISING IN CONTRACT OR WARRANTY, STATUTE, TORT, STRICT LIABILITY, NEGLIGENCE, OR OTHERWISE.**

Banner Engineering Corp. reserves the right to change, modify or improve the design of the product without assuming any obligations or liabilities relating to any product previously manufactured by Banner Engineering Corp. Any misuse, abuse, or improper application or installation of this product or use of the product for personal protection applications when the product is identified as not intended for such purposes will void the product warranty. Any modifications to this product without prior express approval by Banner Engineering Corp will void the product warranties. All specifications published in this document are subject to change; Banner reserves the right to modify product specifications or update documentation at any time. Specifications and product information in English supersede that which is provided in any other language. For the most recent version of any documentation, refer to:

www.bannerengineering.com.